

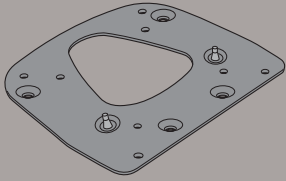

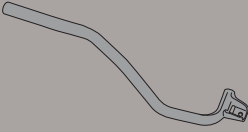



SR6104M – KR6104M

PORTAPACCO SPECIFICO – SPECIFIC HOLDER – PORTE-PAQUET SPÉCIFIQUE – SPEZIFISCHER TRÄGER – PORTA-EQUIPAJE ESPECÍFICO – TRANSPORTADOR ESPECÍFICO

KYMCO XCITING 400i (2013)

N°	Descrizione	Caratteristiche	Codice	Quantità	
1	Supporto - Support - Support Halterung - Soporte - Apoio	Sp. 4mm	GL2374	1	
2	Supporto - Support - Support Halterung - Soporte - Apoio	-	-	2 (Dx;Sx)	
3	Vite - Screw Vis - Schraube Tornillo - Parafuso	TSCEI M8x20	820TSP	2	
4	Vite - Screw Vis - Schraube Tornillo - Parafuso	TSCEI M8x120	8120TSP	2	
5	Distanziale - Spacer Entretoise - Distanzstueck Distanciador - Espaçador	Ø16x2 Lunghezza 48mm	-	2	
6	Dado - Bolt - Ecrou Mutter - Tuerca - Porca	Auto Bloccante Flangiato Ribassato M6	6DADIAFL	2	
7	Particolari Inclusi Nel Kit Viteria Della Piastra Components Included In The Fitting Kit Of The Plate Pièces Inclues Dans Le Kit De Vis De La Platine Die Einzelnen Teile Sind Bei Montagekit Der Platte Enthalten Despieces Incluidos En El Kit De Anclajes De La Parrilla	-	-	-	-
8	Rondella - Washer Rondelle - Scheibe Arandela - Arruela	Ø8	820RON	2	

SR6104M - KR6104M

PORTAPACCO SPECIFICO - SPECIFIC HOLDER - PORTE-PAQUET SPÉCIFIQUE - SPEZIFISCHER TRÄGER - PORTA-EQUIPAJE ESPECÍFICO - TRANSPORTADOR ESPECÍFICO

KYMCO XCITING 400i (2013)

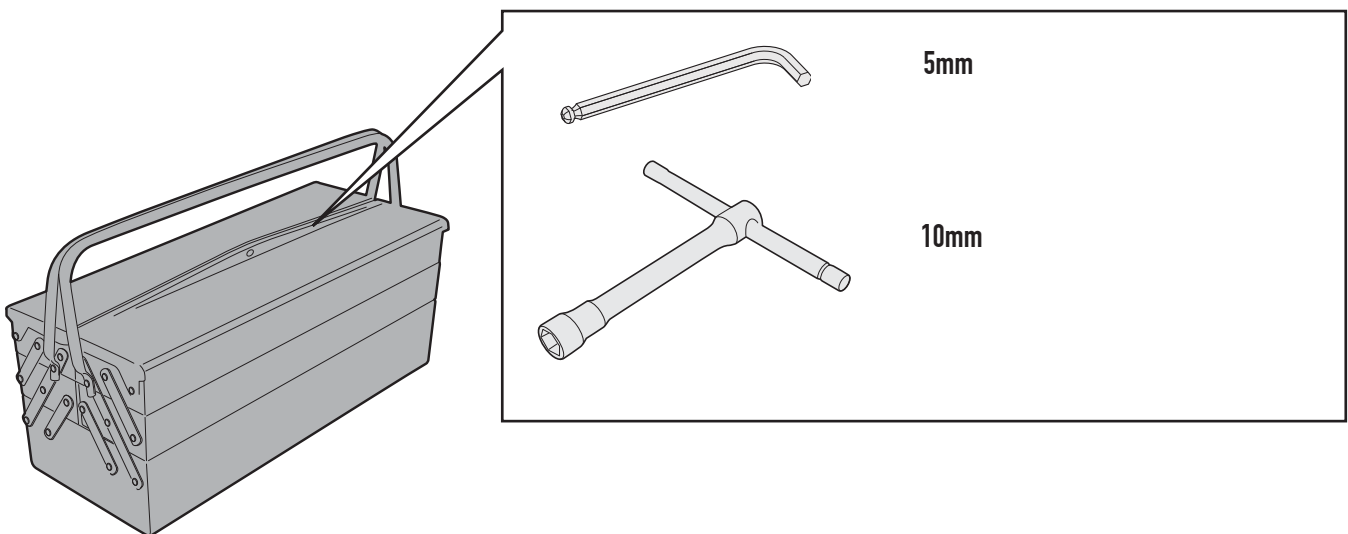

SR6104M - KR6104M

PORTAPACCO SPECIFICO - SPECIFIC HOLDER - PORTE-PAQUET SPÉCIFIQUE - SPEZIFISCHER TRÄGER - PORTA-EQUIPAJE ESPECÍFICO - TRANSPORTADOR ESPECÍFICO

KYMCO XCITING 400i (2013)

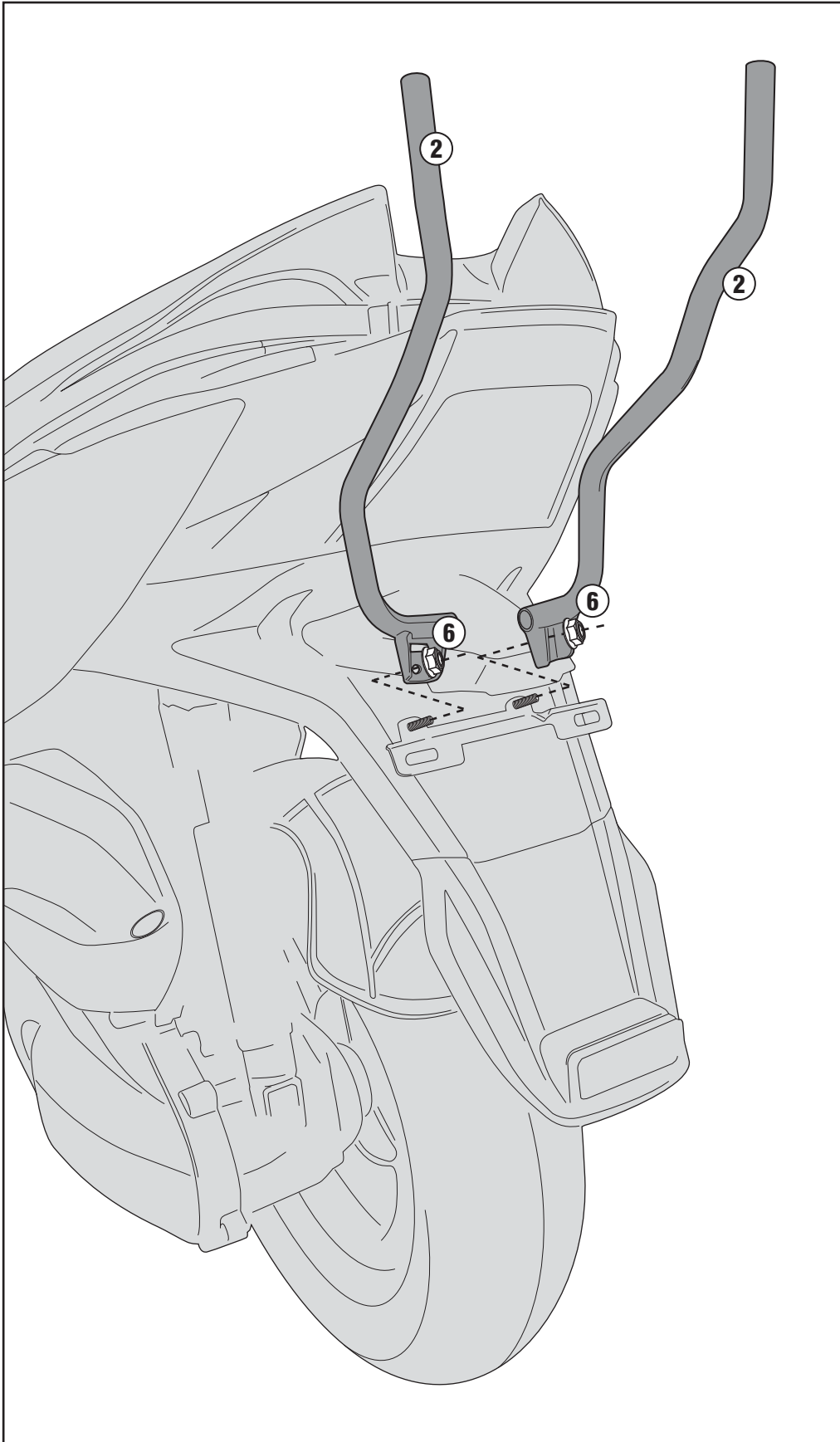

SR6104M - KR6104M

PORTAPACCO SPECIFICO - SPECIFIC HOLDER - PORTE-PAQUET SPECIFIQUE - SPEZIFISCHER TRÄGER - PORTA-EQUIPAJE ESPECÍFICO - TRANSPORTADOR ESPECÍFICO

KYMCO XCITING 400i (2013)

