

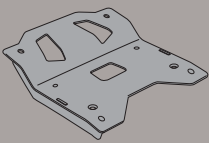

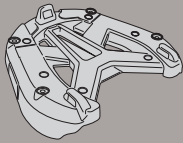







# SR4111 - KR4111

PORTAPACCO SPECIFICO - SPECIFIC HOLDER - PORTE-PAQUET SPÉCIFIQUE - SPEZIFISCHER TRÄGER - PORTA-EQUIPAJE ESPECÍFICO - TRANSPORTADOR ESPECÍFICO

## KAWASAKI J300i (2014)

N°	Descrizione	Caratteristiche	Codice	Quantità	
1	Supporto - Support - Support Halierung - Soporte - Apoio	Sp. 3mm	GL2595	1	
2	Piastra - Plate Platine - Platte Parrilla - Grelha	-	M7	1	
3	Vite - Screw Vis - Schraube Tornillo - Parafuso	TEF M6x50	650TECF	2	
4	Vite - Screw Vis - Schraube Tornillo - Parafuso	TEF M6x55	655TSP	2	
5	Vite - Screw Vis - Schraube Tornillo - Parafuso	TCEI M6x25	625TCE	4	
6	Distanziale - Spacer Entretoise - Distanzstueck Distanciador - Espaçador	Ø18x30 Foro 9,5mm	C18L30F9,5	2	
7	Distanziale - Spacer Entretoise - Distanzstueck Distanciador - Espaçador	Ø18x32 Foro 8,5mm	C18L32F8,5	2	
8	Rondella - Washer Rondelle - Scheibe Arandela - Arruela	Ø6	6RON	4	
9	Rondella - Washer Rondelle - Scheibe Arandela - Arruela	Ø6x18	618RON	4	
10	Dado - Bolt - Ecrou Mutter - Tuerca - Porca	Auto Bloccante M6	6DADIAU	4	
11	Copriforo - Bolt Cap Cache Trou - Stopslock Tapa Agujero - Tampa do Orifício	-	Z621	6	

# SR4111 - KR4111

PORTAPACCO SPECIFICO - SPECIFIC HOLDER - PORTE-PAQUET SPÉCIFIQUE - SPEZIFISCHER TRÄGER - PORTA-EQUIPAJE ESPECÍFICO - TRANSPORTADOR ESPECÍFICO

## KAWASAKI J300i (2014)

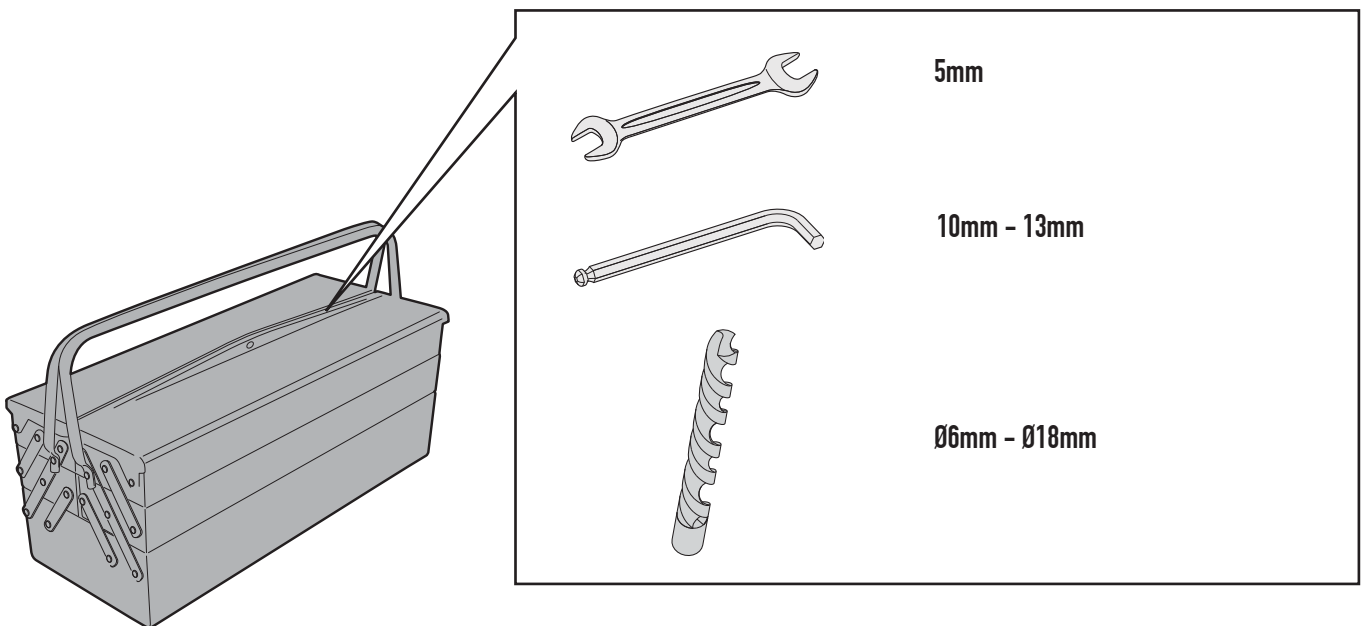

# SR4111 - KR4111

PORTAPACCO SPECIFICO - SPECIFIC HOLDER - PORTE-PAQUET SPÉCIFIQUE - SPEZIFISCHER TRÄGER - PORTA-EQUIPAJE ESPECÍFICO - TRANSPORTADOR ESPECÍFICO

## KAWASAKI J300i (2014)

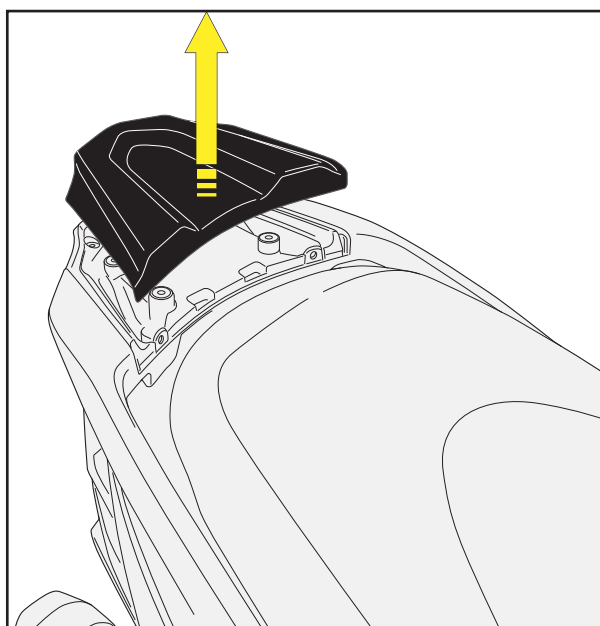

TOGLIERE

REMOVE

ENLEVER

ENTFERNEN

QUITAR

REMOVED

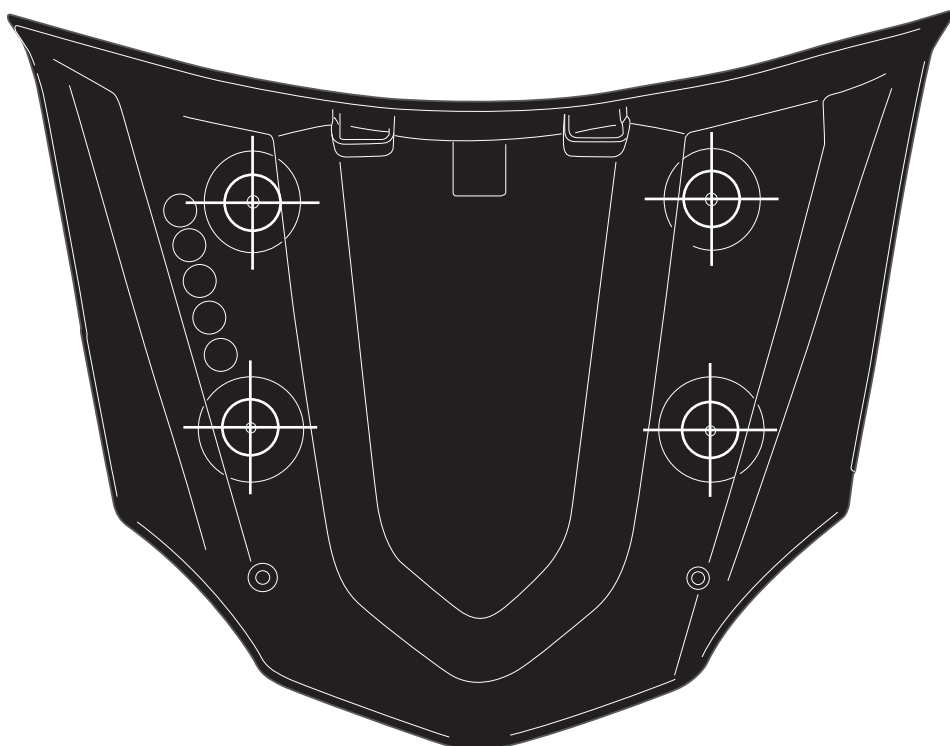
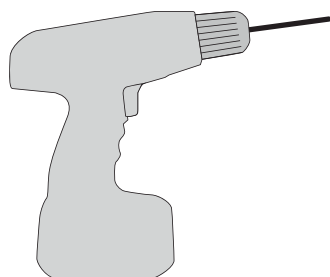

. FORARE NEI 4 PUNTI INDICATI; FORARE PRIMA CON UNA PUNTA PICCOLA ( $\varnothing 6$ ), POI ALLARGARLI CON UNA PUNTA DA 18MM.

. PIERCE THE 4 POINTS MARKED; START WITH A SMALL POINT ( $\varnothing 6$ ) AND CHECK THE POINTS ARE LINED UP WITH THE ORIGINAL SCREWS BELOW; THEN ENLARGE THE HOLES WITH A  $\varnothing 18$  POINT.

. PERCER LES 4 POINTS INDIQUE EN COMMENCANT AVEC UN FORET 6MM, VERIFIER QU'ILS SONT A LIGNE AVEC LES VIS ORIGINALES DESSOUS, POIS AGGRANDIR LES TROUS AVEC UN FORET DE 18MM.

MIT EINEM 6MM BOHRER VORBOHREN; DANN ÜBERPRÜFEN OB DIE BOHRUGEN MIT DEN ORIGINALSCHRAUBEN MITTING SIND; JETZT DIE LOCHER AUF 18MM AUFBOHREN.

. AGUJERAR EN LOS 4 PUNTOS INDICADOS; AGUJERAR PRIMERO CON LA PUNTA PEQUENA ( $\varnothing 6$ ), CONTROLAR QUE CONICIDAN CON LOS TORNILLOS QUE SE ENCUENTRAN EN EL CHASIS DE LA MOTO, LUEGO AMPLIAR EL AGUJERO CON UNA PUNTA DE 18MM.

. AGUJERAR EN LOS 4 PUNTOS INDICADOS; LUEGO EL AMPLIAR AGUJERO CON UN POCO DE 18 MILÍMETROS.

ISTRUZIONI DI MONTAGGIO - MOUNTING INSTRUCTIONS  
INSTRUCTIONS DE MONTAGE - BAUANLEITUNG  
INSTRUCCIONES DE MONTAJE - INSTRUÇÕES DE MONTAGEM

# SR4111 - KR4111

PORTAPACCO SPECIFICO - SPECIFIC HOLDER - PORTE-PAQUET SPECIFIQUE - SPEZIFISCHER TRÄGER - PORTA-EQUIPAJE ESPECÍFICO - TRANSPORTADOR ESPECÍFICO

## KAWASAKI J300i (2014)

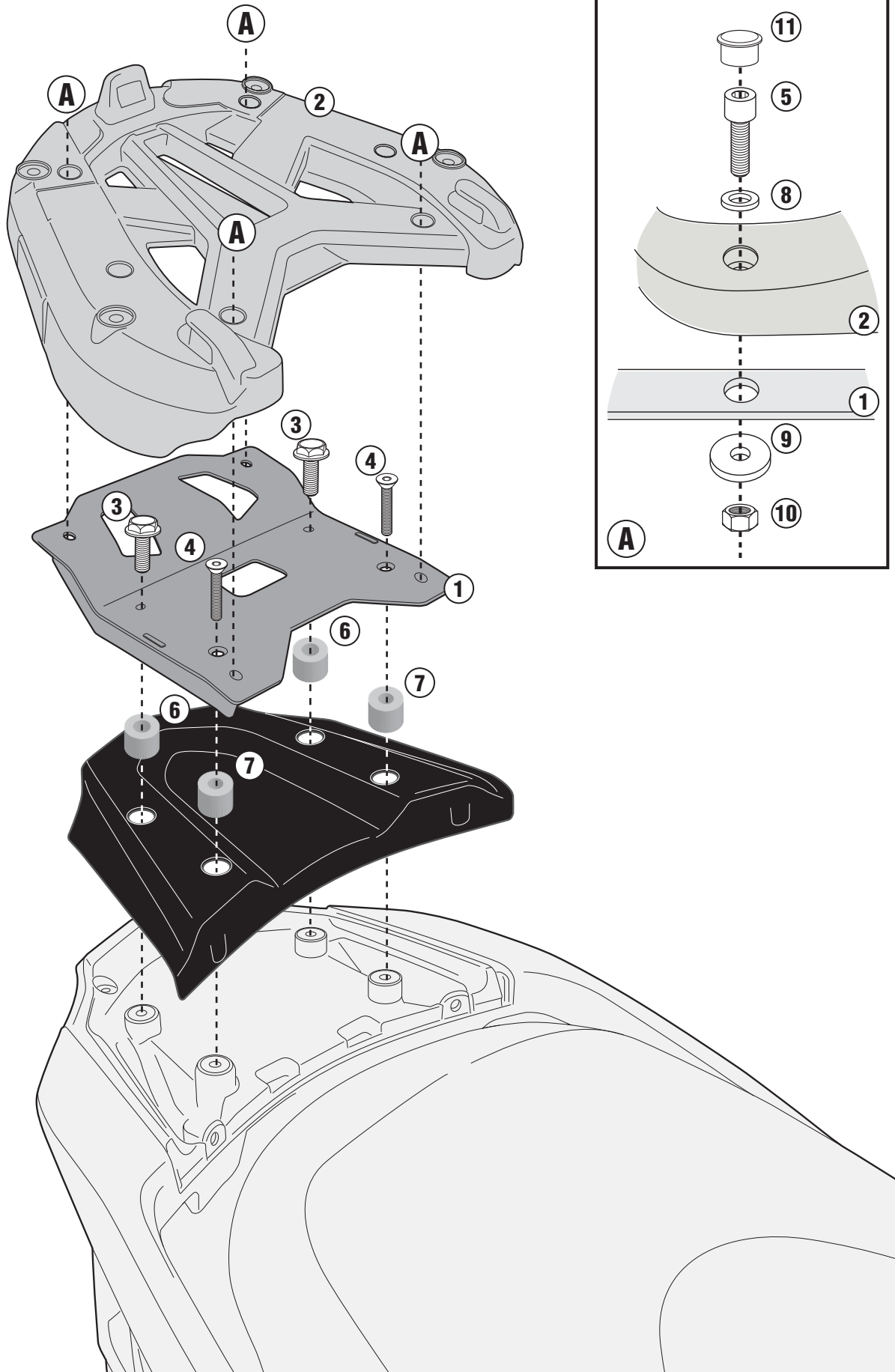

ISTRUZIONI DI MONTAGGIO - MOUNTING INSTRUCTIONS  
INSTRUCTIONS DE MONTAGE - BAUANLEITUNG  
INSTRUCCIONES DE MONTAJE - INSTRUÇÕES DE MONTAGEM