

SR2123 - KR2123

PORTAPACCO SPECIFICO - SPECIFIC HOLDER - PORTE-PAQUET SPÉCIFIQUE - SPEZIFISCHER TRÄGER - PORTA-EQUIPAJE ESPECÍFICO - TRANSPORTADOR ESPECÍFICO

YAMAHA NMAX 125 (2015)

N°	Descrizione	Caratteristiche	Codice	Quantità
1	Supporto - Support - Support Halteung - Soporte - Apoio	-	2123SRS	1
2	Supporto - Support - Support Halteung - Soporte - Apoio	-	GL3004	2
3	Supporto - Support - Support Halteung - Soporte - Apoio	-	GL3005	2
4	Vite - Screw Vis - Schraube Tornillo - Parafuso	TEF M8x90	890TEF	2
5	Vite - Screw Vis - Schraube Tornillo - Parafuso	TEF M8x30	830TECF	4
6	Dado - Bolt - Erou Mutter - Tuerca - Porca	Dado Auto Bloccante Flangiato M8	8DADIAFL	2
7	Distanziale - Spacer Entretoise - Distanzstueck Distanciador - Espaçador	Ø18x18 foro 8,5mm	C18L18F8.5T	4
8	Distanziale - Spacer Entretoise - Distanzstueck Distanciador - Espaçador	Ø16x26 Foro 8,5mm	C16L26F8.5T	2
9	Componenti Originali - Original Parts Parties Originales - Original Bauteile Componentes Originales - Componentes Originais	-	-	-

SR2123 - KR2123

PORTAPACCO SPECIFICO - SPECIFIC HOLDER - PORTE-PAQUET SPÉCIFIQUE - SPEZIFISCHER TRÄGER - PORTA-EQUIPAJE ESPECÍFICO - TRANSPORTADOR ESPECÍFICO

YAMAHA NMAX 125 (2015)

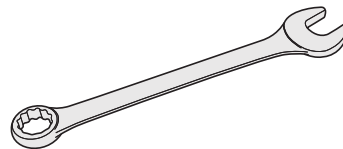
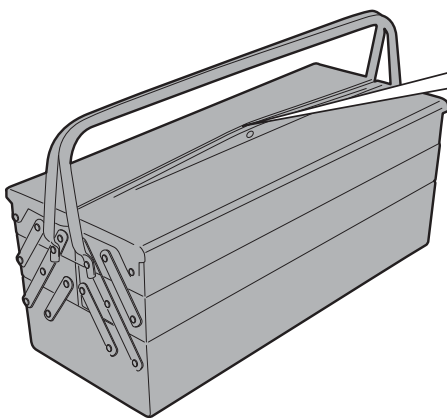
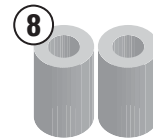
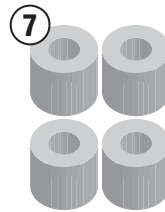
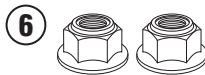
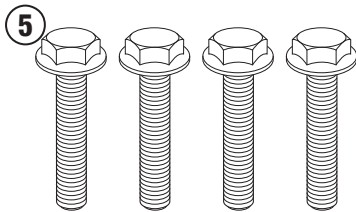
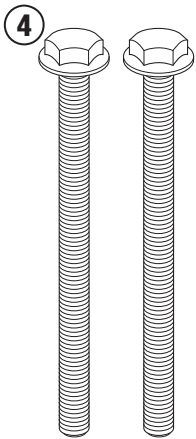
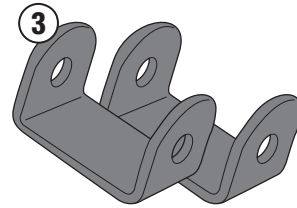
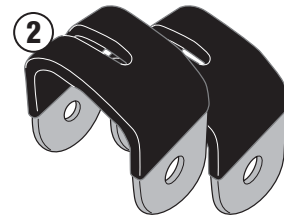
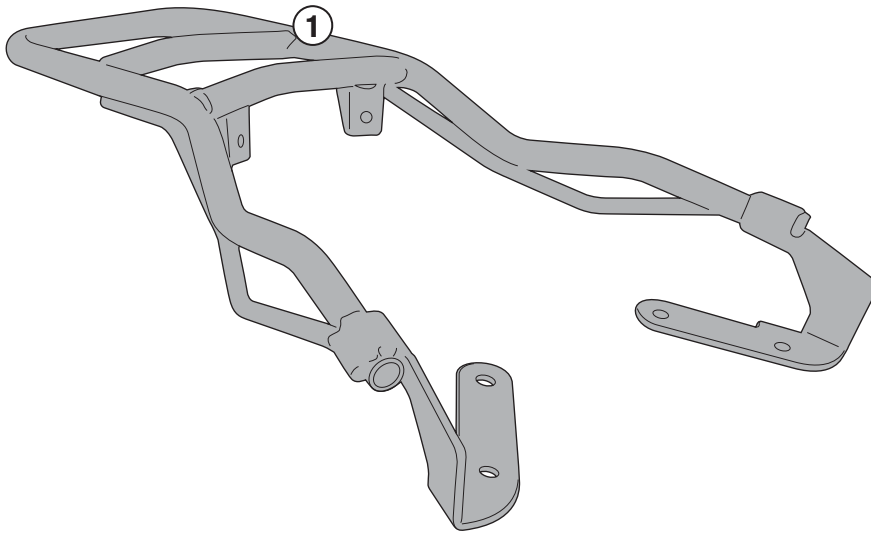

12mm, 13mm



SR2123 - KR2123

PORTAPACCO SPECIFICO - SPECIFIC HOLDER - PORTE-PAQUET SPÉCIFIQUE - SPEZIFISCHER TRÄGER - PORTA-EQUIPAJE ESPECÍFICO - TRANSPORTADOR ESPECÍFICO

YAMAHA NMAX 125 (2015)

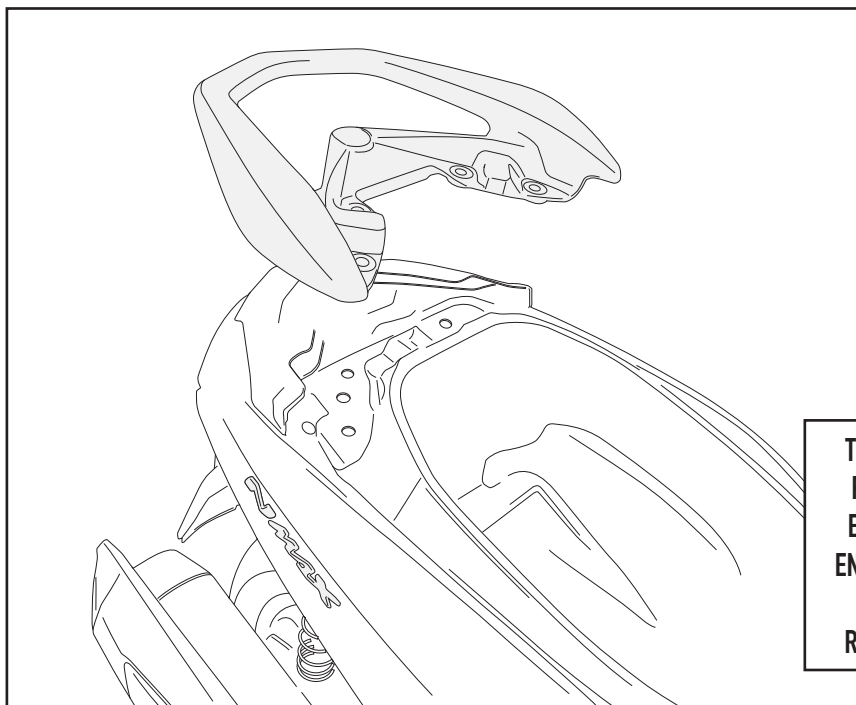

TOGLIERE
REMOVE
ENLEVER
ENTFERNEN
QUITAR
REMOVED

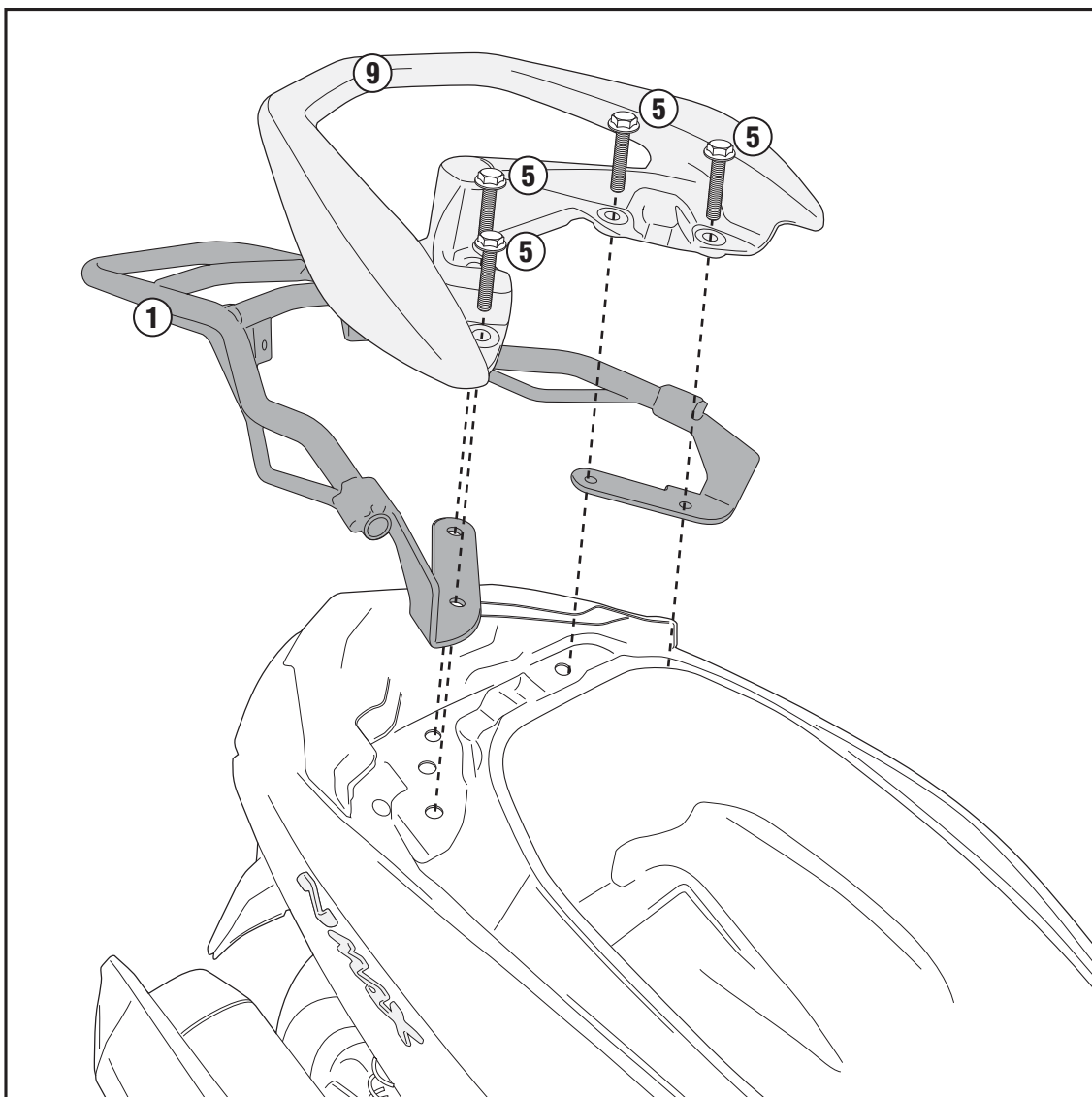

ISTRUZIONI DI MONTAGGIO - MOUNTING INSTRUCTIONS
INSTRUCTIONS DE MONTAGE - BAUANLEITUNG
INSTRUCCIONES DE MONTAJE - INSTRUÇÕES DE MONTAGEM

SR2123 - KR2123

PORTAPACCO SPECIFICO - SPECIFIC HOLDER - PORTE-PAQUET SPÉCIFIQUE - SPEZIFISCHER TRÄGER - PORTA-EQUIPAJE ESPECÍFICO - TRANSPORTADOR ESPECÍFICO

YAMAHA NMAX 125 (2015)

