

PLR2139 - KLR2139

PORTAVALIGIE LATERALE SPECIFICO - SPECIFIC TUBULAR SIDE-CASE HOLDER - PORTE-VALISES LATÉRAUX SPÉCIFIQUE
 SPEZIFISCHES STAHLROHR-SEITENTRAEGER - PORTA MALETAS LATERALES ESPECÍFICO - TRONCO LADO ESPECÍFICO
YAMAHA TRACER 900(2018)/ TRACER 900 GT(2018)

N°	Descrizione	Caratteristiche	Codice	Quantità
1	Telaio laterale - Side frame - Châssis latéral - Soporte lateral - Seitenrahmen - Suporte lateral	-	PLR2139DXV PLR2139SXV	2 (Right;Left)
2	Supporto inferiore - Lower support - Support inférieur - Soporte inferior - Untere Halterung - Suporte inferior	-	GL3889DXV GL3889SXV	2 (Right;Left)
3	Ponte - Bridge - Pont Brücke - Puente - Ponte	-	GNB2143V	1
4	Boccola - Mounting bush - Entretoise de montage Cilindro de fijación - Montagehülse - Bucha de fixação	-	Z2379	2
5	Vite - Screw Vis - Schraube Tornillo - Parafuso	TECF M8x20	820TECF	2
6	Vite - Screw Vis - Schraube Tornillo - Parafuso	TECF M8x30	830TECF	2
7	Vite - Screw Vis - Schraube Tornillo - Parafuso	TBEI M8x55	855TBEI	2
8	Distanziale - Spacer Entretoise - Distanzstueck Distanciador - Espaçador	Ø14x8 Foro 8,5mm	C14L8F8,5T	2
9	Distanziale - Spacer Entretoise - Distanzstueck Distanciador - Espaçador	Ø16x28 Foro 8,5mm	C16L28F8,5ALT	2
10	Protezione specifica - Specific protection Protection spécifique - Spezifischer Schutz Protector específico - Protetor específico	-	Z9870DX Z9870SX	2 (Front Right Side; Front Left Side)
11	Protezione specifica - Specific protection Protection spécifique - Spezifischer Schutz Protector específico - Protetor específico	-	Z9871DX Z9871SX	2(Rear Right Side; Rear Left Si)
12	Chiave Per Viti A Testa Speciale - Special Key Cle Speciale - Spezialschlüssel Llave Para Tornillos Con Cabeza Especial	-	PLXRC	1
13	Particolari Inclusi nel 2139KIT Components Included In The 2139KIT Pièces Inclues Dans 2139KIT Die Einzelnen Teile Sind Bei 2139KIT Despieces Incluidos 2139KIT Componentes incluidos na base 2139KIT	-	-	-
14	Particolari Inclusi nel SR2139 Components Included In The SR2139 Pièces Inclues Dans SR2139 Die Einzelnen Teile Sind Bei SR2139 Despieces Incluidos SR2139 Componentes incluidos na SR2139	-	-	-

PLR2139 - KLR2139

PORTAVALIGIE LATERALE SPECIFICO - SPECIFIC TUBULAR SIDE-CASE HOLDER - PORTE-VALISES LATÉRAUX SPÉCIFIQUE

SPEZIFISCHES STAHLROHR-SEITENTRAEGER - PORTA MALETAS LATERALES ESPECÍFICO - TRONCO LADO ESPECÍFICO

YAMAHA TRACER 900(2018)/ TRACER 900 GT(2018)

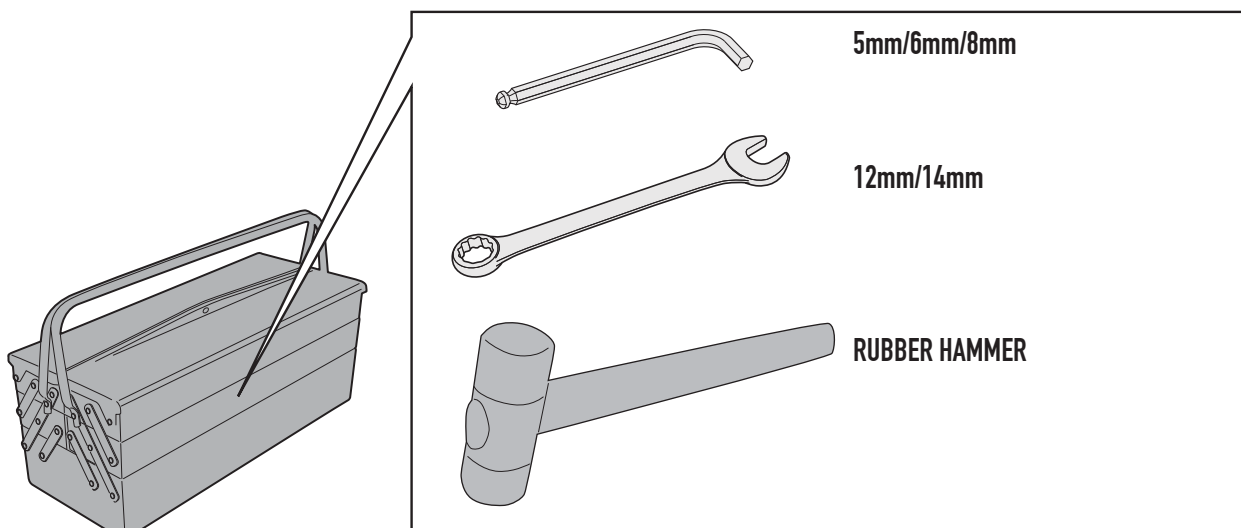
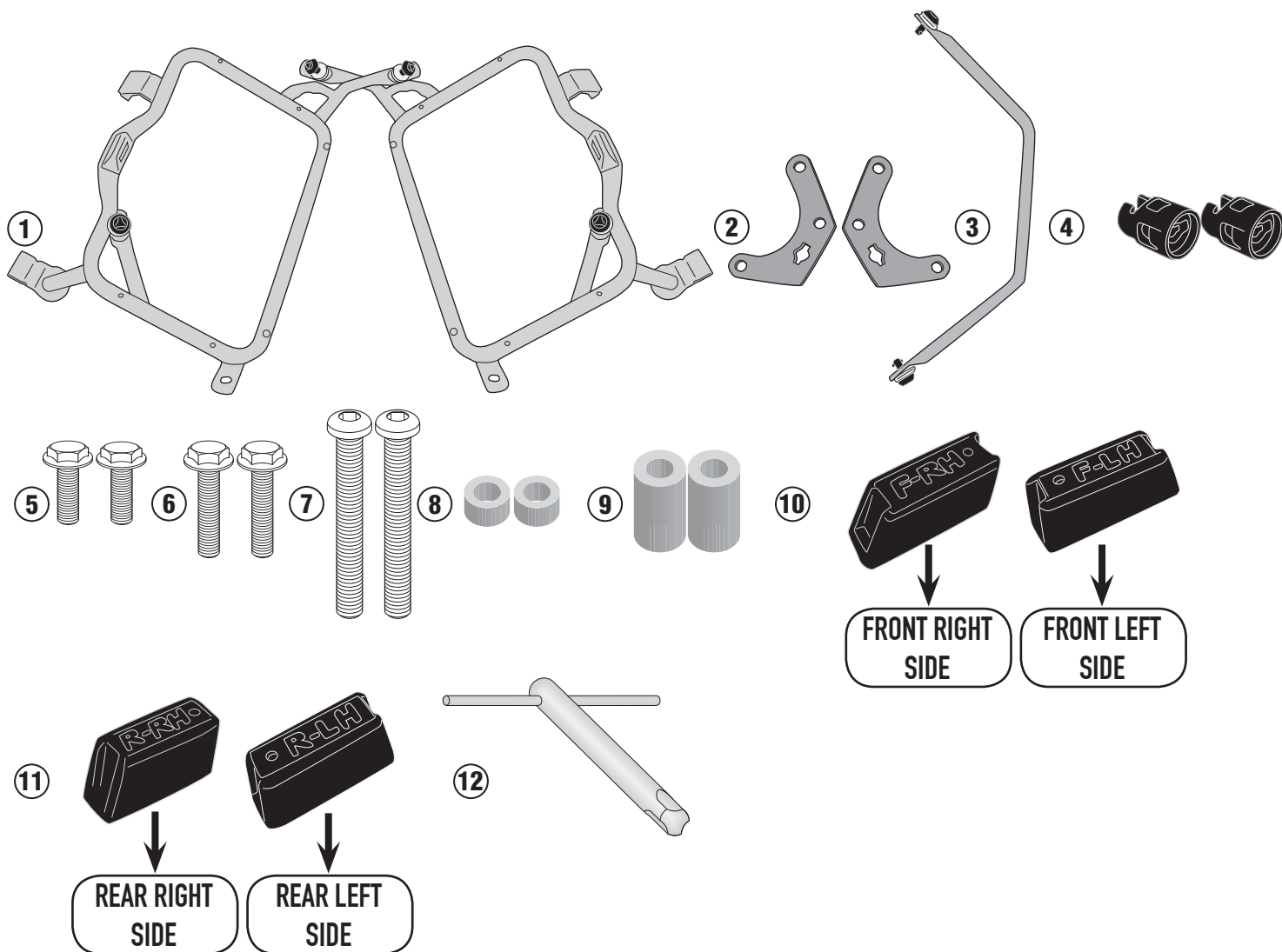

PLR2139 - KLR2139

PORTAVALIGIE LATERALE SPECIFICO - SPECIFIC TUBULAR SIDE-CASE HOLDER - PORTE-VALISES LATÉRAUX SPÉCIFIQUE

SPEZIFISCHES STAHLROHR-SEITENTRAEGER - PORTA MALETAS LATERALES ESPECÍFICO - TRONCO LADO ESPECÍFICO

YAMAHA TRACER 900(2018)/ TRACER 900 GT(2018)

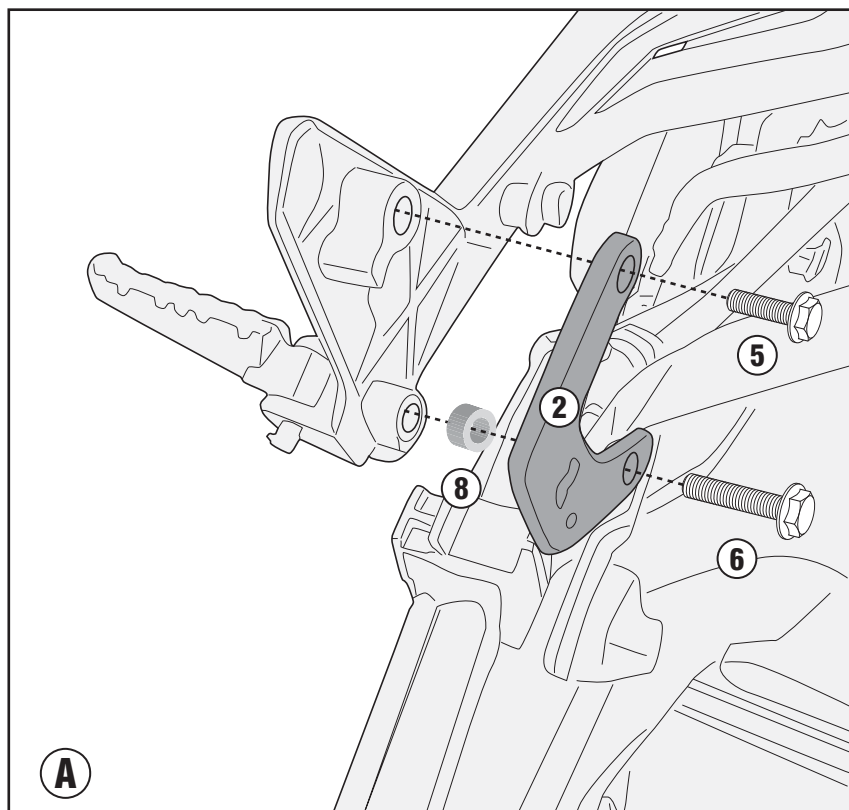
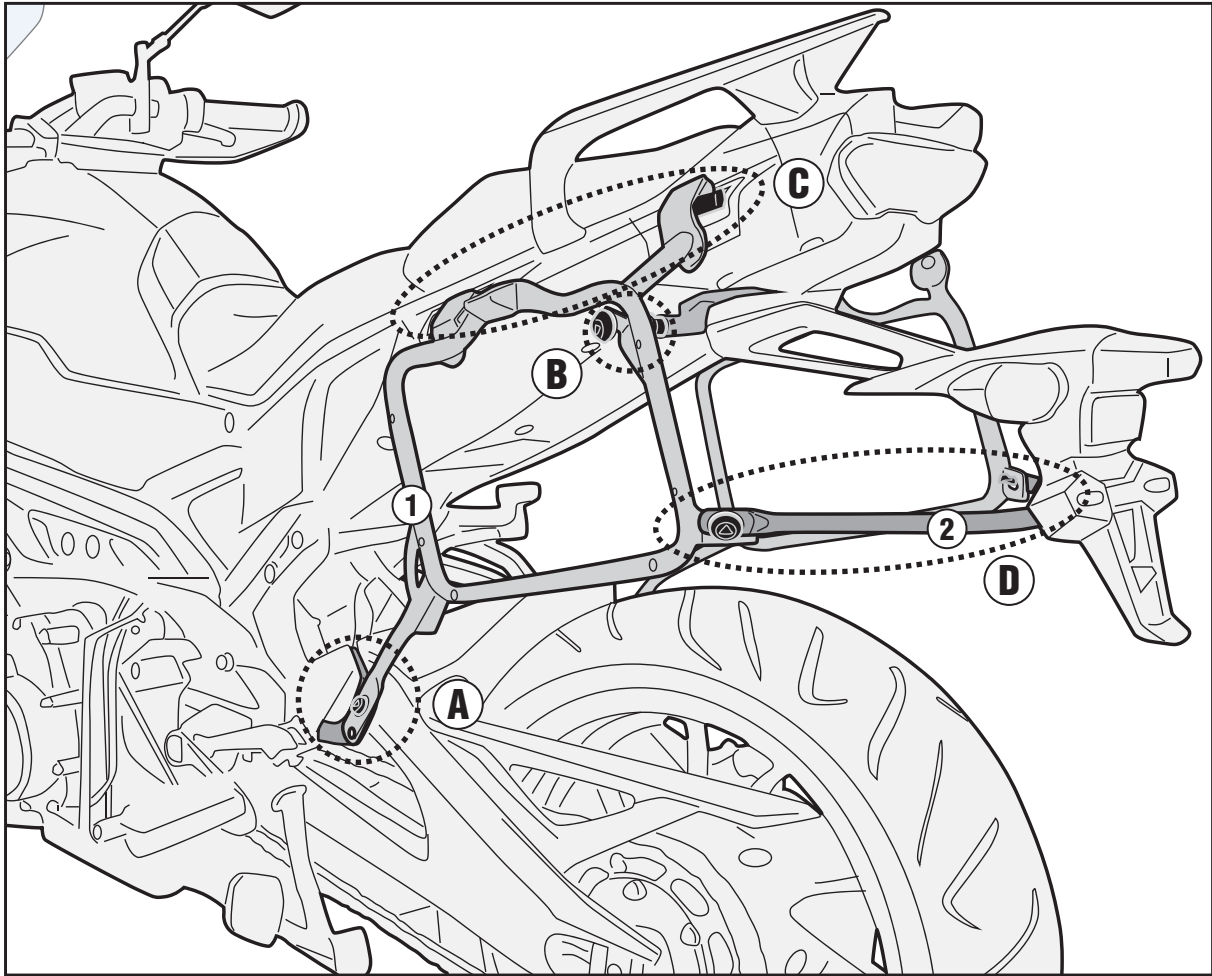

PLR2139 - KLR2139

PORTAVALIGIE LATERALE SPECIFICO - SPECIFIC TUBULAR SIDE-CASE HOLDER - PORTE-VALISES LATÉRAUX SPÉCIFIQUE

SPEZIFISCHES STAHLROHR-SEITENTRAEGER - PORTA MALETAS LATERALES ESPECÍFICO - TRONCO LADO ESPECÍFICO

YAMAHA TRACER 900(2018)/ TRACER 900 GT(2018)

ONLY PLR2139



SR2139+ PLR2139

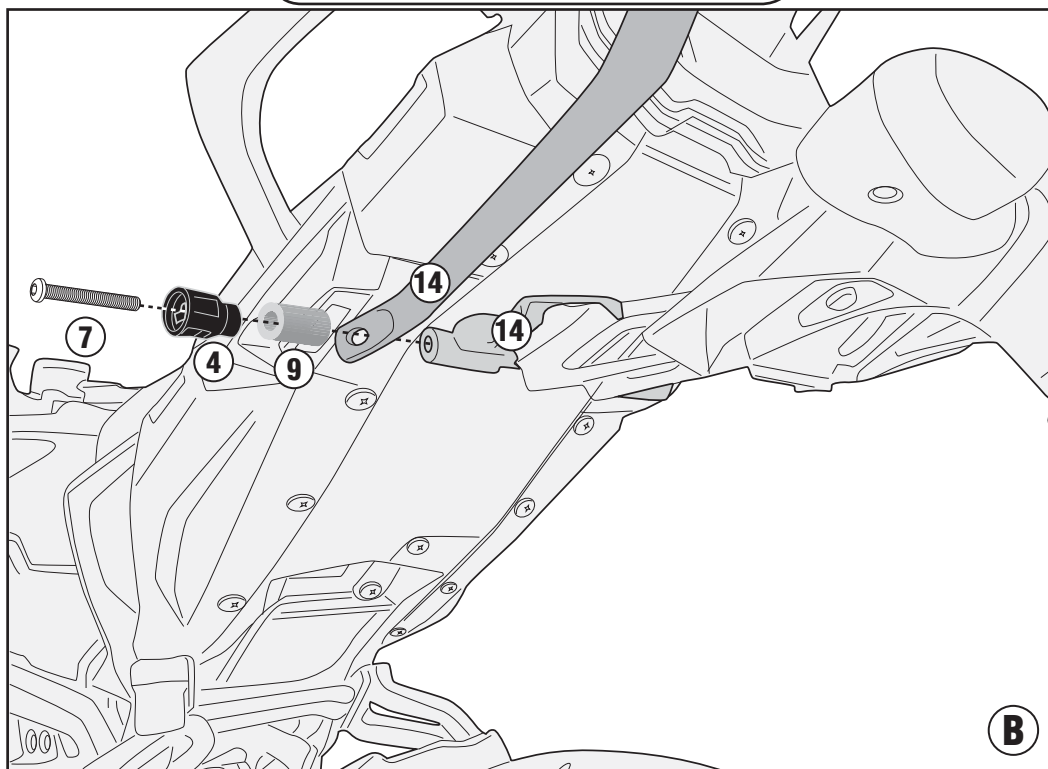

PLR2139 - KLR2139

PORTAVALIGIE LATERALE SPECIFICO - SPECIFIC TUBULAR SIDE-CASE HOLDER - PORTE-VALISES LATÉRAUX SPÉCIFIQUE

SPEZIFISCHES STAHLROHR-SEITENTRAEGER - PORTA MALETAS LATERALES ESPECÍFICO - TRONCO LADO ESPECÍFICO

YAMAHA TRACER 900(2018)/ TRACER 900 GT(2018)

LEFT SIDE

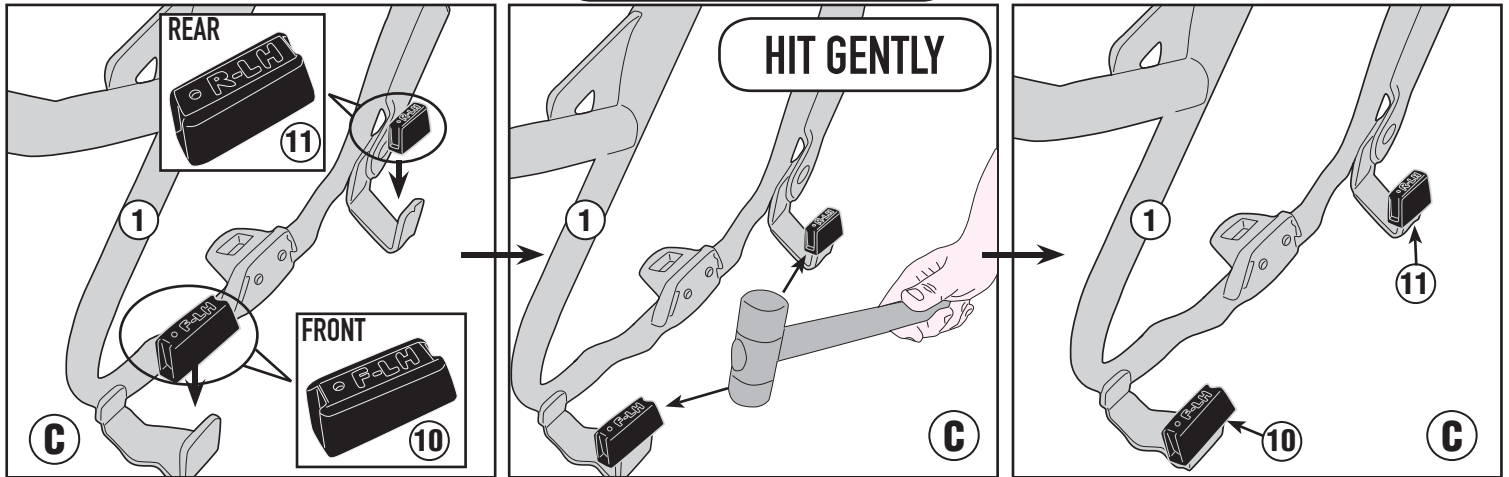

RIGHT SIDE

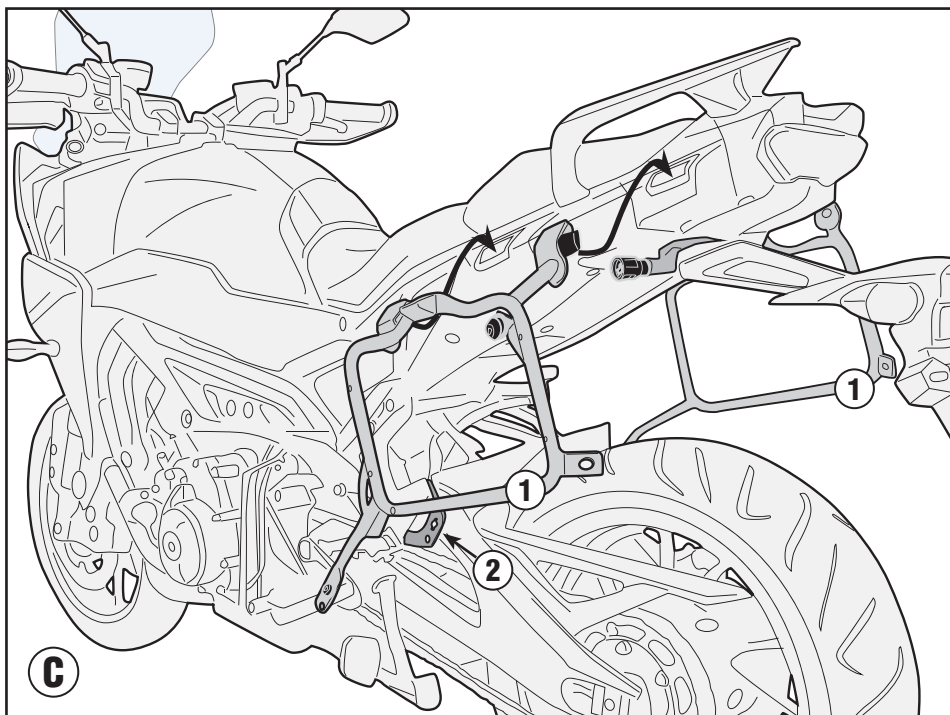
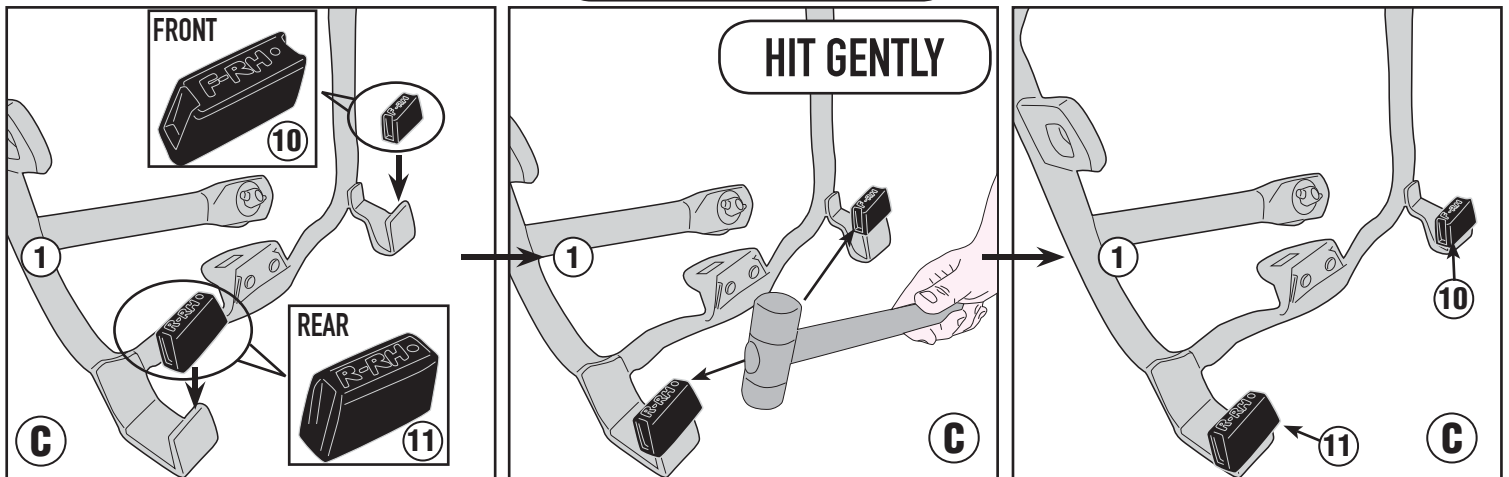

PLR2139 - KLR2139

PORTAVALIGIE LATERALE SPECIFICO - SPECIFIC TUBULAR SIDE-CASE HOLDER - PORTE-VALISES LATÉRAUX SPÉCIFIQUE
SPEZIFISCHES STAHLROHR-SEITENTRAEGER - PORTA MALETAS LATERALES ESPECÍFICO - TRONCO LADO ESPECÍFICO

YAMAHA TRACER 900(2018)/ TRACER 900 GT(2018)

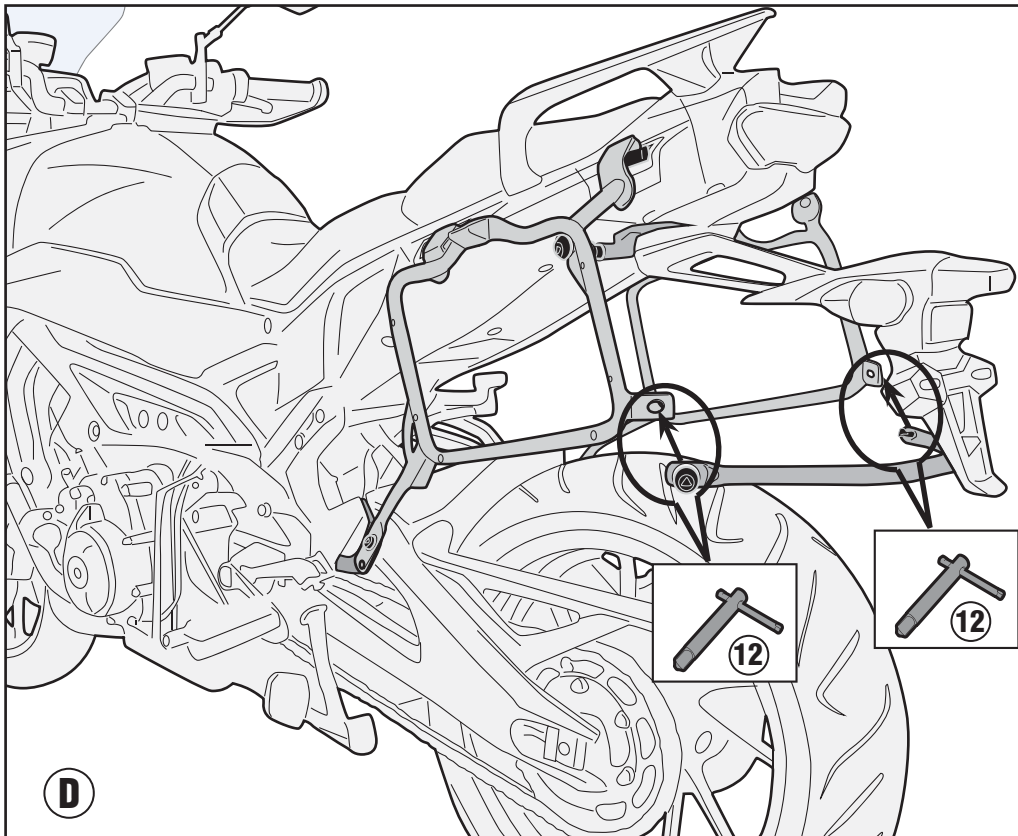
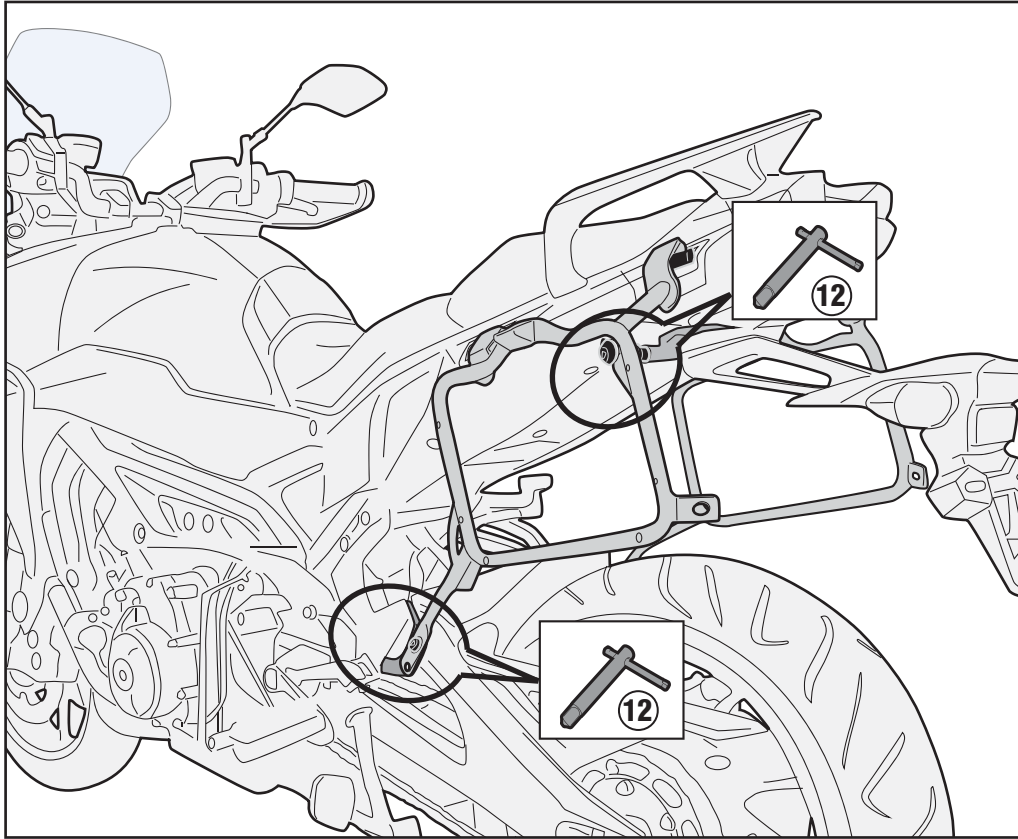

PLR2139 - KLR2139

PORTAVALIGIE LATERALE SPECIFICO - SPECIFIC TUBULAR SIDE-CASE HOLDER - PORTE-VALISES LATÉRAUX SPÉCIFIQUE
SPEZIFISCHES STAHLROHR-SEITENTRAEGER - PORTA MALETAS LATERALES ESPECÍFICO - TRONCO LADO ESPECÍFICO

YAMAHA TRACER 900(2018)/ TRACER 900 GT(2018)

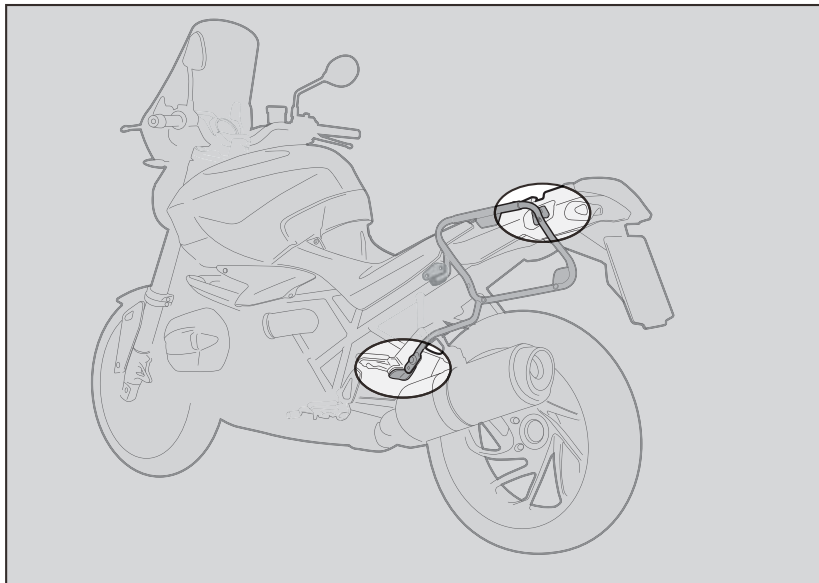

1. INSERIRE L'ATTREZZO NELLA TESTA DELLA VITE SPECIALE;
2. RUOTARE DI 1/4 DI GIRO IN SENSO ORARIO FINO A CHE LA ROTAZIONE NON TERMINA E SI AVVERTE LO SCATTO;
3. PER SMONTARE PROCEDERE IN SENSO INVERSO.

1. INSERT THE SPECIAL KEY INTO THE HEAD OF THE SCREW;
2. TURN THE KEY ¼ TURN CLOCKWISE UNTIL ROTATION STOPS AND THE SIDE CASE HOLDER IS FASTENED SECURELY TO THE FITMENT POINT;
3. IN ORDER TO DISASSEMBLE THE BRACKETRY PERFORM THE OPERATION IN REVERSE.

1. INSERER LA CLE SPECIALE DANS LA TÊTE DE LA VIS;
2. VISSER D'¼ DE TOUR DANS LE SENS HORAIRE JUSQU'AU BLOCAGE DE LA VIS POUR MONTER EN TOUTE SECURITE LE SUPPORT A SON POINT DE FIXATION;
3. POUR LE DEMONTAGE, PROCEDER EN SENSE INVERSE.

1. STECKEN SIE DAS WERKZEUG IN DEN KOPF DER SPEZIFISCHEN SCHRAUBE;
2. DREHEN SIE DIE SCHRAUBE 1 / 4 UMDREHUNG IM UHRZEIGERSINN BIS SIE BEMERKEN, DASS DIE SCHRAUBE IM BEFESTIGUNGSPUNKT EINGEKLEMMT IST;
3. FÜR DIE DEMONTAGE FOLGEN SIE DEN HINWEISE UMGEKEHRT.

1. INSERTAR LA LLAVE ESPECIAL EN LA CABEZA DEL TORNILLO
2. DAR ¼ DE VUELTA EN EL SENTIDO HORARIO HASTA QUE LLEGUE AL TOPE Y SE VEA EL TORNILLO;
3. PARA DESMONTARLO PROCEDER EN LA DIRECCIÓN CONTRARIA;

MONTAGGIO - ASSEMBLY - MONTAGE - MONTAGE - MONTAJE

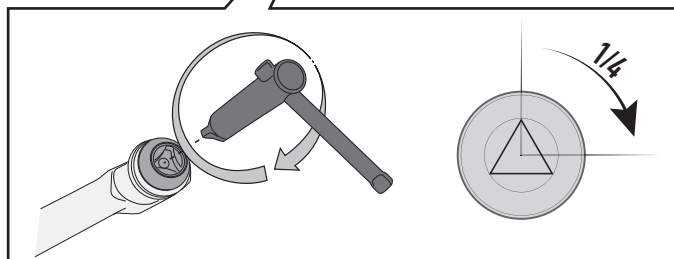
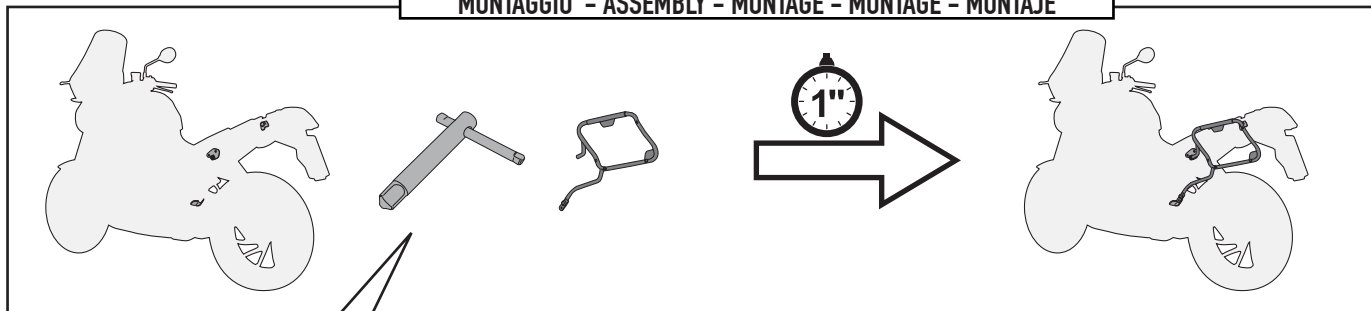

SMONTAGGIO - DISASSEMBLY - DÉMONTAGE - DEMONTAGE - DESMONTAJE

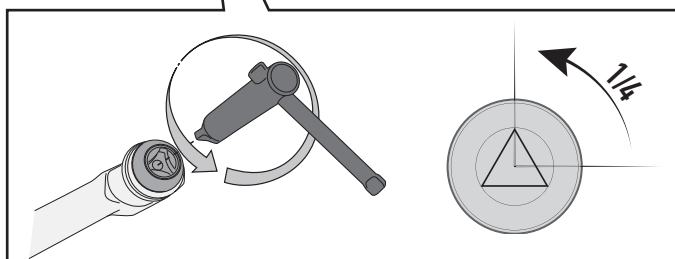
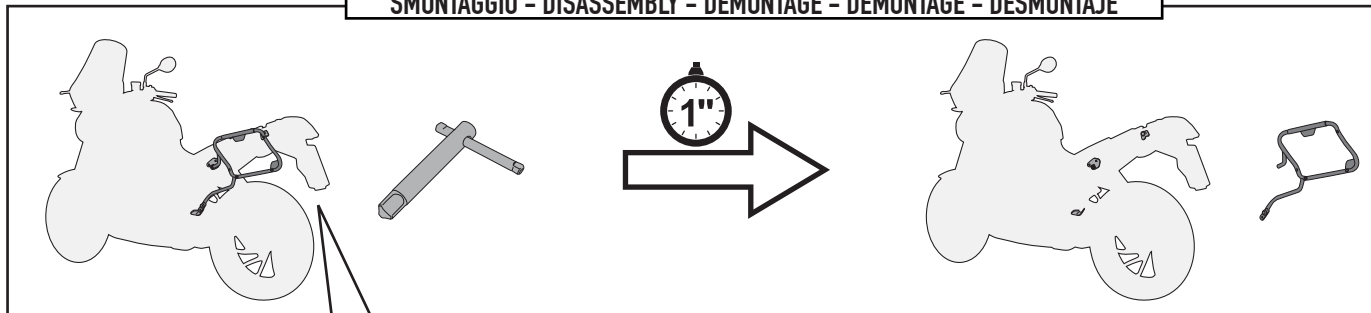

PLR2139 - KLR2139

PORTAVALIGIE LATERALE SPECIFICO - SPECIFIC TUBULAR SIDE-CASE HOLDER - PORTE-VALISES LATÉRAUX SPÉCIFIQUE
SPEZIFISCHES STAHLROHR-SEITENTRAEGER - PORTA MALETAS LATERALES ESPECÍFICO - TRONCO LADO ESPECÍFICO

YAMAHA TRACER 900(2018)/ TRACER 900 GT(2018)

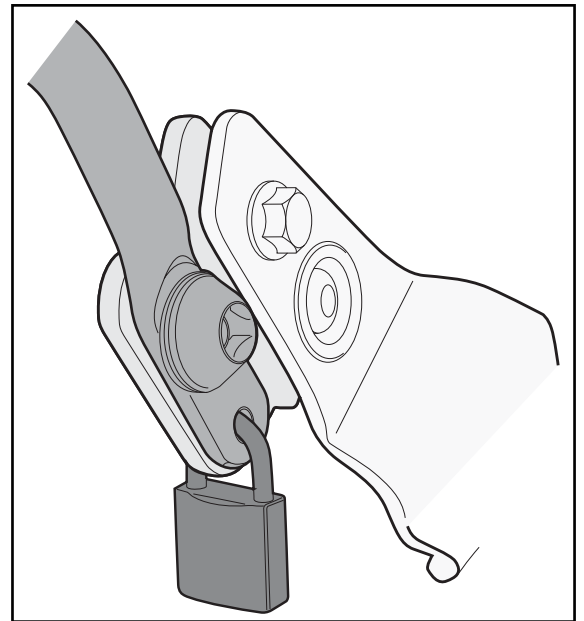
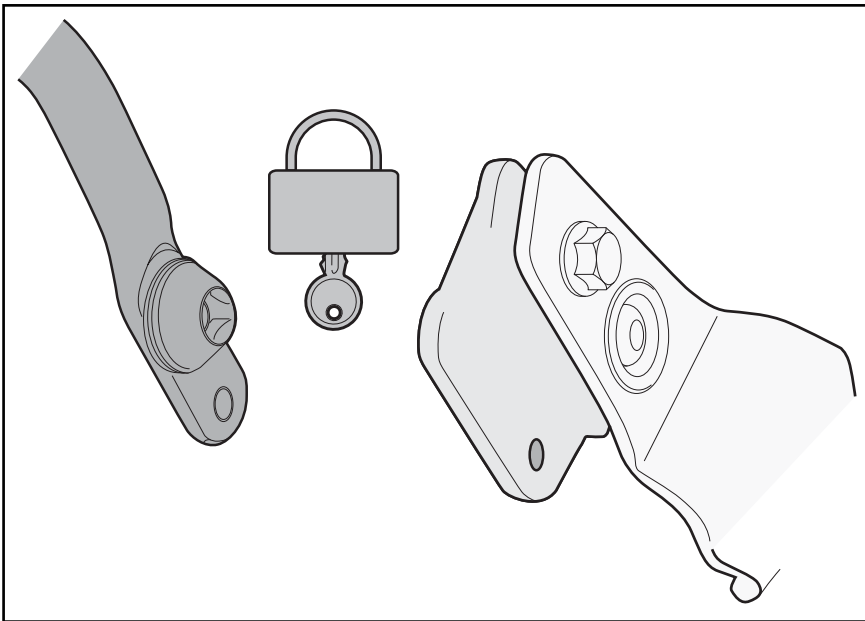
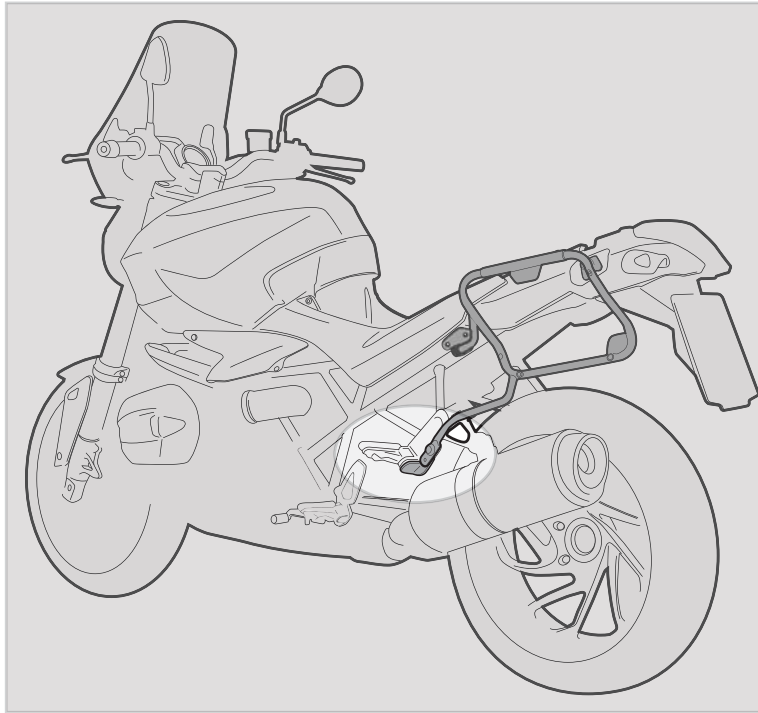

FORO DI SICUREZZA

FORO PREDISPOSTO AD ASSICURARE IL PORTAVALIGIE LATERALE ALLA MOTO (CON UN LUCCHETTO PER ESEMPIO, NON INCLUSO).

SECURITY HOLE

HOLE PLACEMENT IN ORDER TO INCREASE SECURITY OF THE TUBULAR SIDE-CASE HOLDER TO THE MOTORCYCLE (WITH A LOCK, FOR EXAMPLE, NOT INCLUDED).

TROU DE SECURITE

TROU PREDISPOSE POUR ASSURER LE PORTE-VALISE LATERAL A LA MOTO (AVEC UN CADENAS PAR EXEMPLE, NON INCLUS).

SICHERHEITSLOCH

VORGESEHENES LOCH UM DEN SEITENKOFFER TRÄGER AN DEM FAHRZEUG ZU SICHERN (Z. B. MIT EINEM VORHÄNGESCHLOSS, NICHT ENHALTEN).

ORIFICIO DE SEGURIDAD

ESTE ORIFICIO ESTA CREADO PARA ASEGURAR EL PORTAEQUIPAJES LATERAL A LA MOTO (POR EJEMPLO CON UN CANDADO, QUE NO ESTÁ INCLUIDO).