

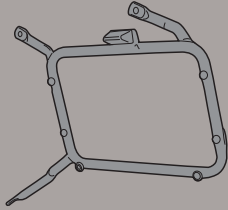

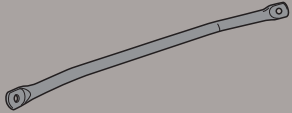

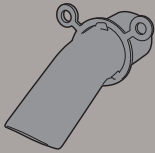



PL1121 - KL1121

PORTAVALIGIE LATERALE SPECIFICO - SPECIFIC TUBULAR SIDE-CASE HOLDER - PORTE-VALISES LATÉRAUX SPÉCIFIQUE
 SPEZIFISCHES STAHLROHR-SEITENTRAEGER - PORTA MALETAS LATERALES ESPECÍFICO - TRONCO LADO ESPECÍFICO

HONDA CB500X (2013)

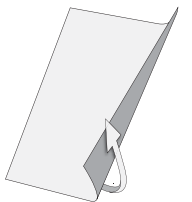

N°	Descrizione	Caratteristiche	Codice	Quantità	
1	Supporto - Support - Support Halteung - Soporte - Apoio	-	PL1121DXS PL1121SXS	2 (Dx,Sx)	
2	Ponte Posteriore - Rear Bridge - Pont Postérieure Verbindungsrohr - Puente Trasero - Ponte Traseira	-	GNB1239V	1	
3	Supporto - Support - Support Halteung - Soporte - Apoio	-	GNB1240T	1	
4	Vite - Screw Vis - Schraube Tornillo - Parafuso	TE M8x55	855TEF	1	
5	Vite - Screw Vis - Schraube Tornillo - Parafuso	TEF M6x16	616TEF	2	
6	Vite - Screw Vis - Schraube Tornillo - Parafuso	TECF M6x50	650TECF	1	
7	Vite - Screw Vis - Schraube Tornillo - Parafuso	TEF M8x40	840TBEI	4	
8	Vite - Screw Vis - Schraube Tornillo - Parafuso	TBEI M6x25	625TBEI	2	
9	Dado - Bolt - Ecrou Mutter - Tuerca - Porca	Dado Auto Bloccante Flangiato M6	6DADIAFLN	3	
10	Distanziale - Spacer Entretoise - Distanzstueck Distanciador - Espaçador	Ø14x3 M6	V261	1	



PL1121 - KL1121

PORTAVALIGIE LATERALE SPECIFICO - SPECIFIC TUBULAR SIDE-CASE HOLDER - PORTE-VALISES LATÉRAUX SPÉCIFIQUE
 SPEZIFISCHES STAHLROHR-SEITENTRAEGER - PORTA MALETAS LATERALES ESPECÍFICO - TRONCO LADO ESPECÍFICO

HONDA CB500X (2013)

N°	Descrizione	Caratteristiche	Codice	Quantità	
11	Rondella - Washer Rondelle - Scheibe Arandela - Arruela	Ø18 Foro 6mm	618RON	1	
12	Rondella - Washer Rondelle - Scheibe Arandela - Arruela	Ø14 Foro 8mm	814RON	4	
13	Distanziale - Spacer Entretoise - Distanzstueck Distanciador - Espaçador	Ø14x4 Foro 6.5mm	C14L4F6.5T	2	
14	Particolari Inclusi Nel 1121FZ Components Included In the 1121FZ Pièces Incluses Dans Le 1121FZ Die Einzelnen Teile Sind Bei Montagekit Der 1121FZ Despieces Incluidos En El 1121FZ Explodiu incluido no 1121FZ	-	-	-	-
15	Particolari Inclusi Nel 1121KIT Components Included In the 1121KIT Pièces Incluses Dans Le 1121KIT Die Einzelnen Teile Sind Bei Montagekit Der 1121KIT Despieces Incluidos En El 1121KIT Explodiu incluido no 1121KIT	-	-	-	-
16	Componenti Originali - Original Parts Parties Originales - Original Bauteile Componentes Originales - Componentes Originais	-	-	-	-

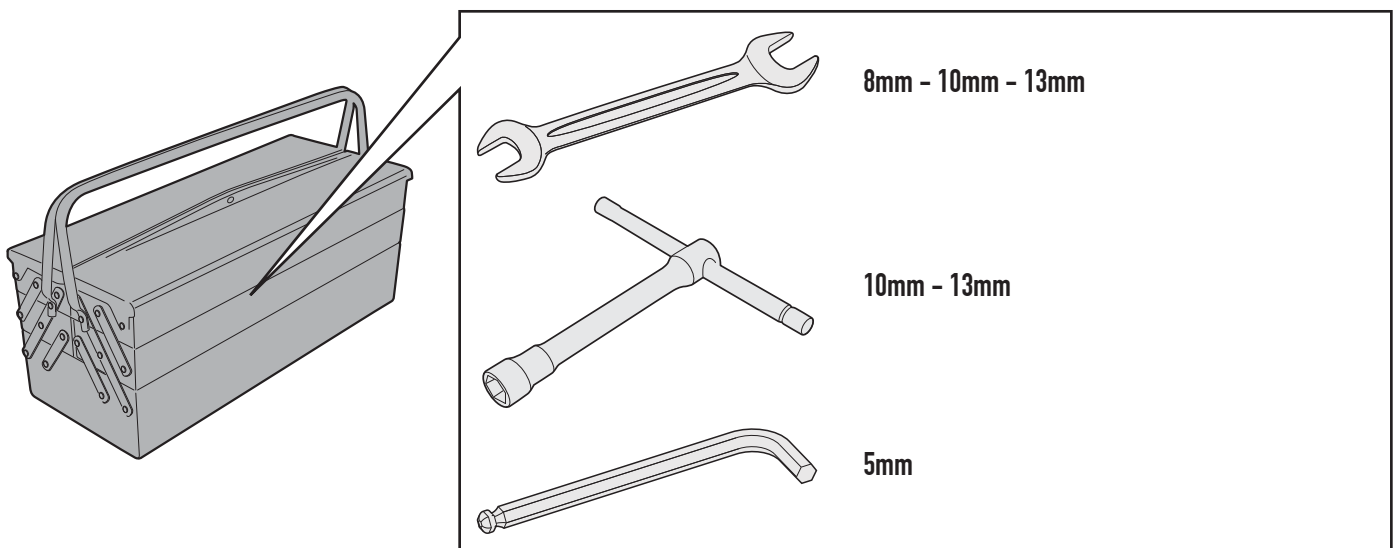

ISTRUZIONI DI MONTAGGIO - MOUNTING INSTRUCTIONS
 INSTRUCTIONS DE MONTAGE - BAUANLEITUNG
 INSTRUCCIONES DE MONTAJE - INSTRUÇÕES DE MONTAGEM

PL1121 - KL1121

PORTAVALIGIE LATERALE SPECIFICO - SPECIFIC TUBULAR SIDE-CASE HOLDER - PORTE-VALISES LATÉRAUX SPÉCIFIQUE
SPEZIFISCHES STAHLROHR-SEITENTRAEGER - PORTA MALETAS LATERALES ESPECÍFICO - TRONCO LADO ESPECÍFICO

HONDA CB500X (2013)

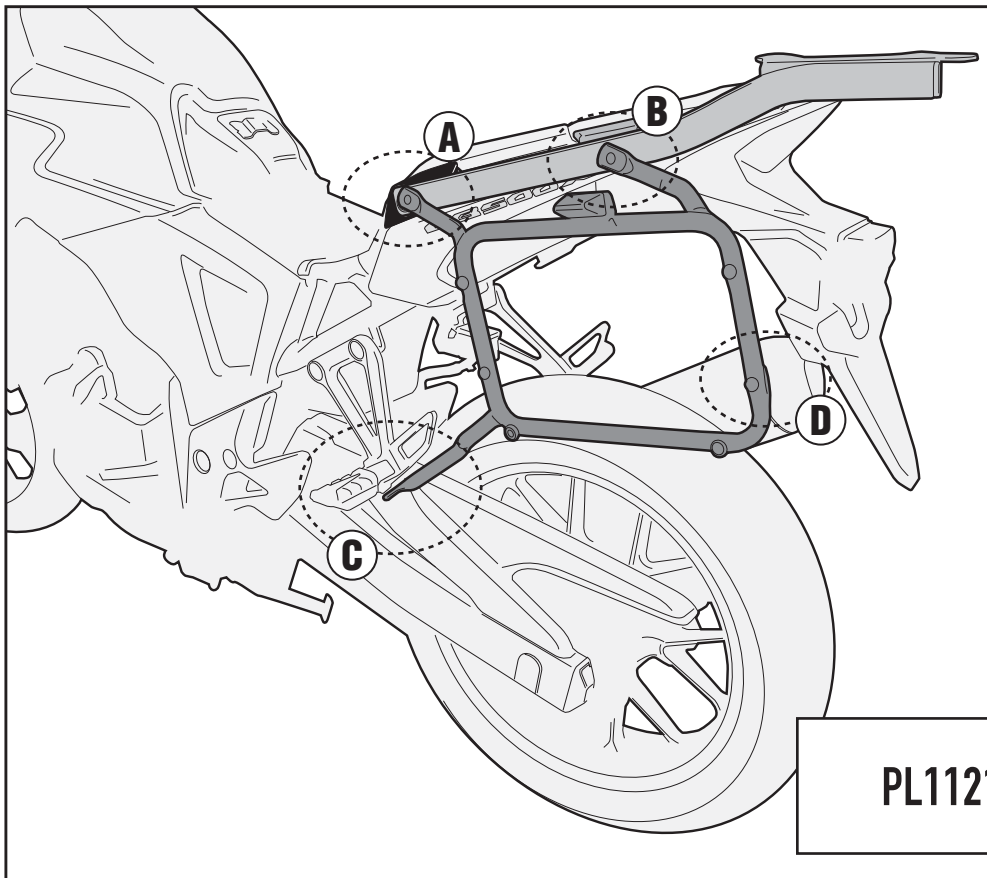

PL1121 + 1121FZ

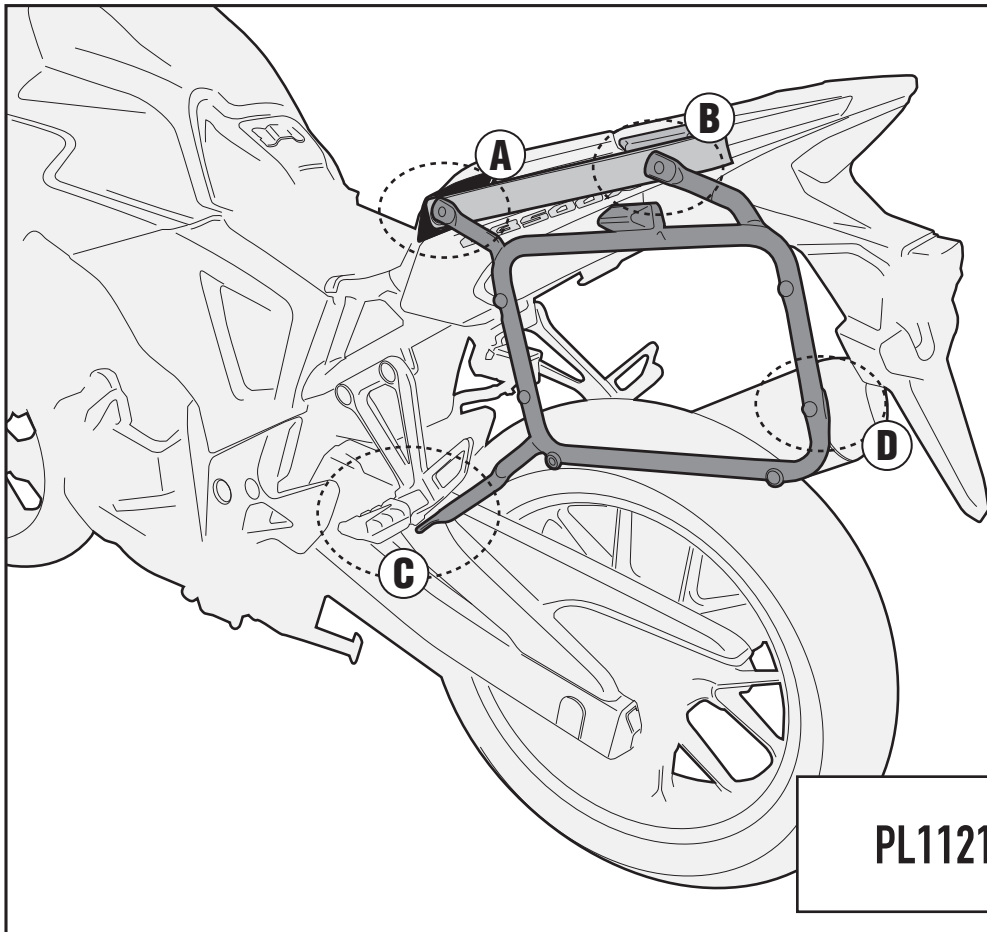

PL1121 + 1121KIT

PL1121 - KL1121

PORTAVALIGIE LATERALE SPECIFICO - SPECIFIC TUBULAR SIDE-CASE HOLDER - PORTE-VALISES LATÉRAUX SPÉCIFIQUE
SPEZIFISCHES STAHLROHR-SEITENTRAEGER - PORTA MALETAS LATERALES ESPECÍFICO - TRONCO LADO ESPECÍFICO

HONDA CB500X (2013)

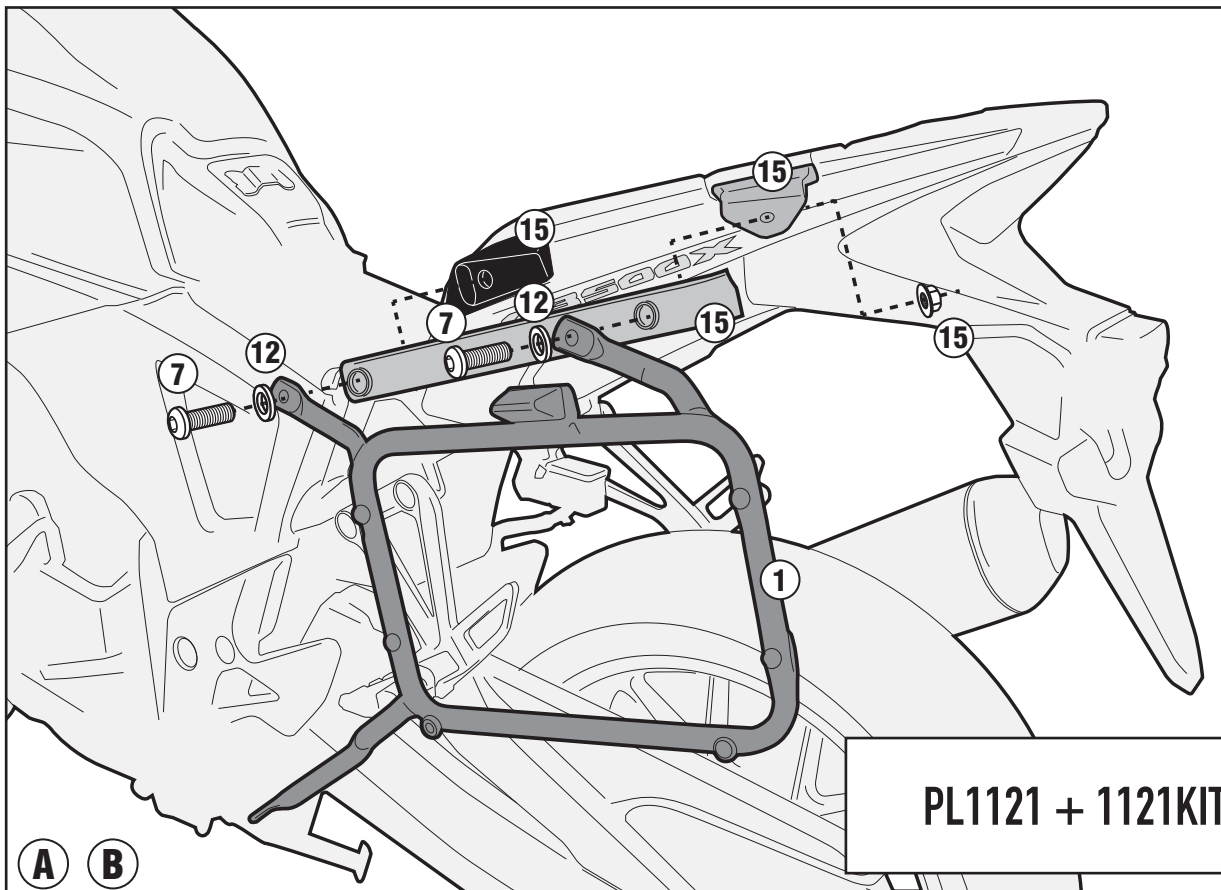
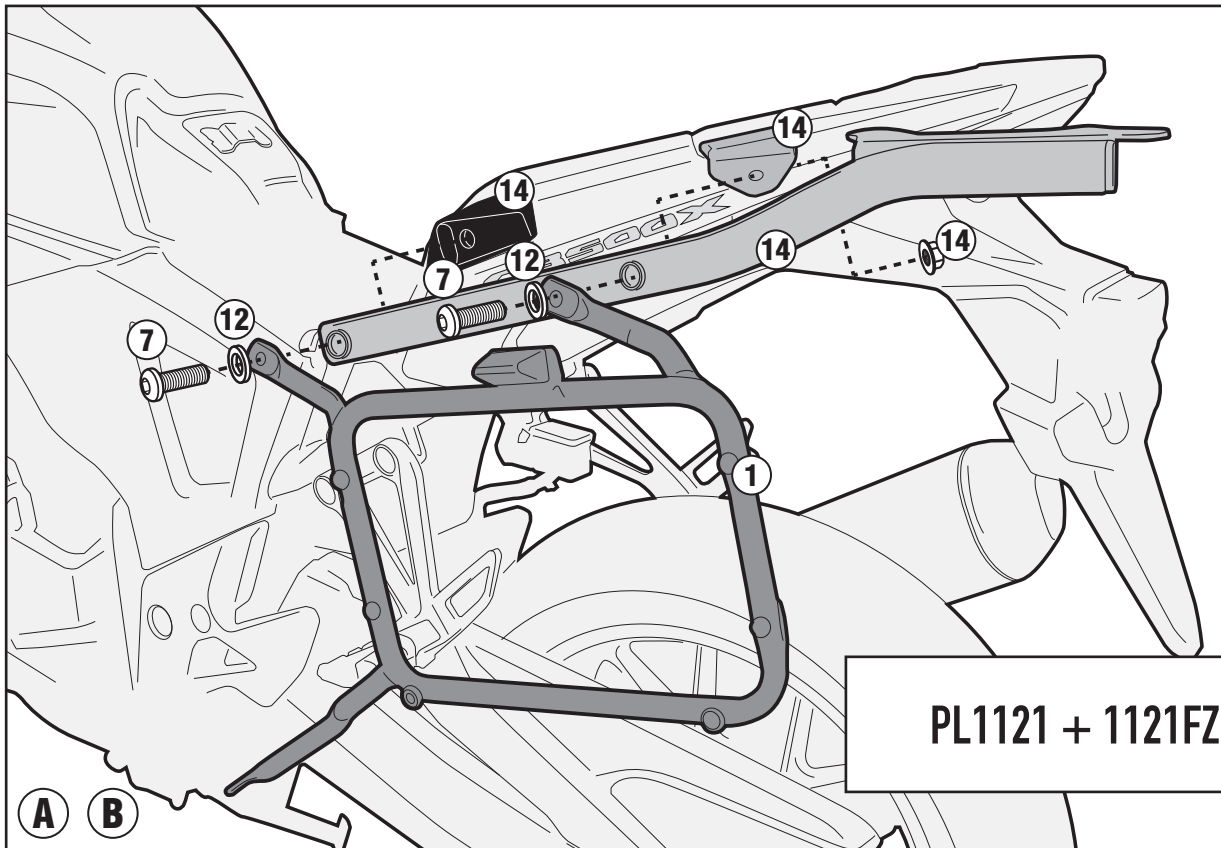

PL1121 - KL1121

PORTAVALIGIE LATERALE SPECIFICO - SPECIFIC TUBULAR SIDE-CASE HOLDER - PORTE-VALISES LATÉRAUX SPÉCIFIQUE
SPEZIFISCHES STAHLROHR-SEITENTRAEGER - PORTA MALETAS LATERALES ESPECÍFICO - TRONCO LADO ESPECÍFICO

HONDA CB500X (2013)

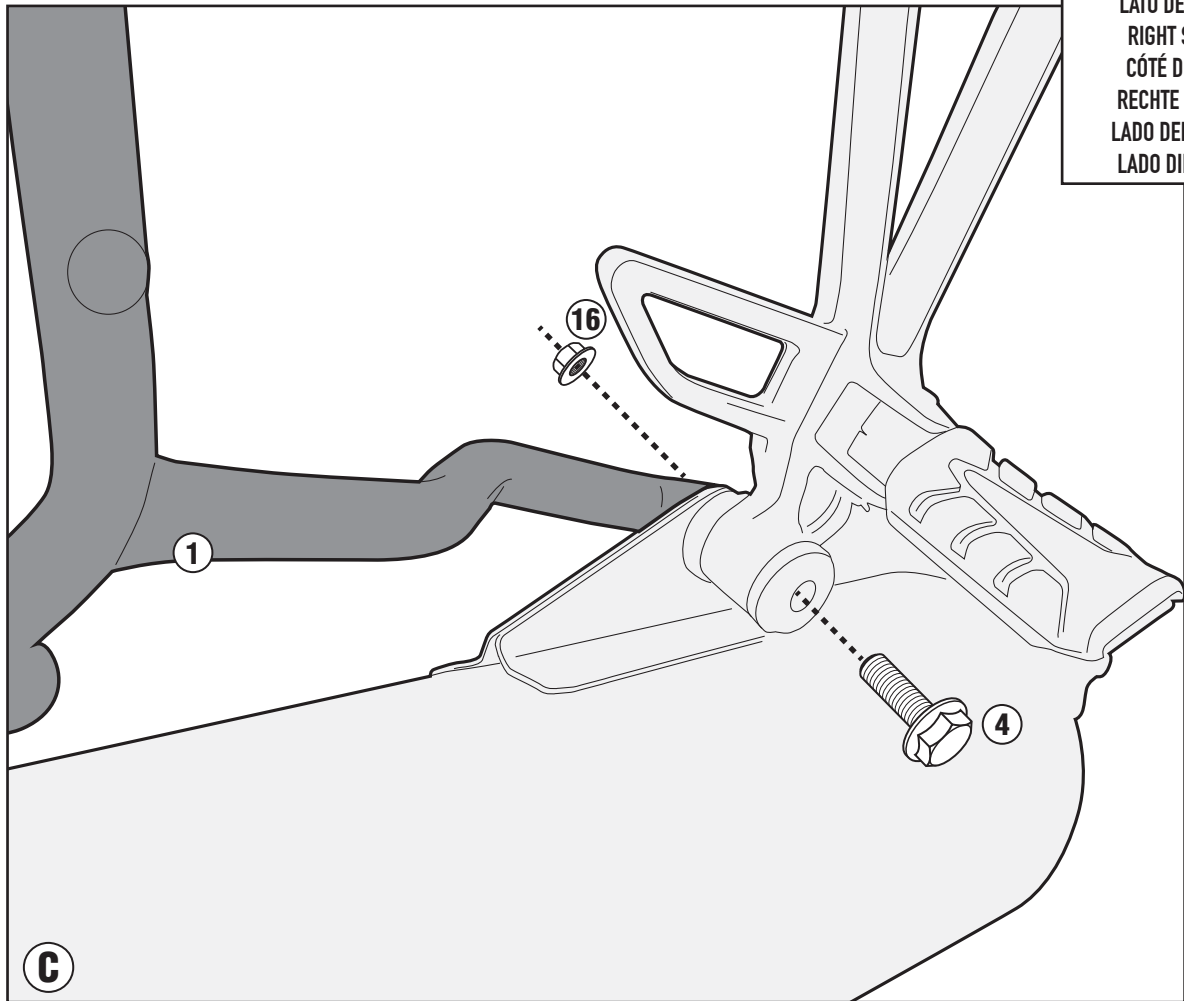

LATO DESTRO
RIGHT SIDE
CÔTÉ DROIT
RECHTE SEITE
LADO DERECHO
LADO DIREITO

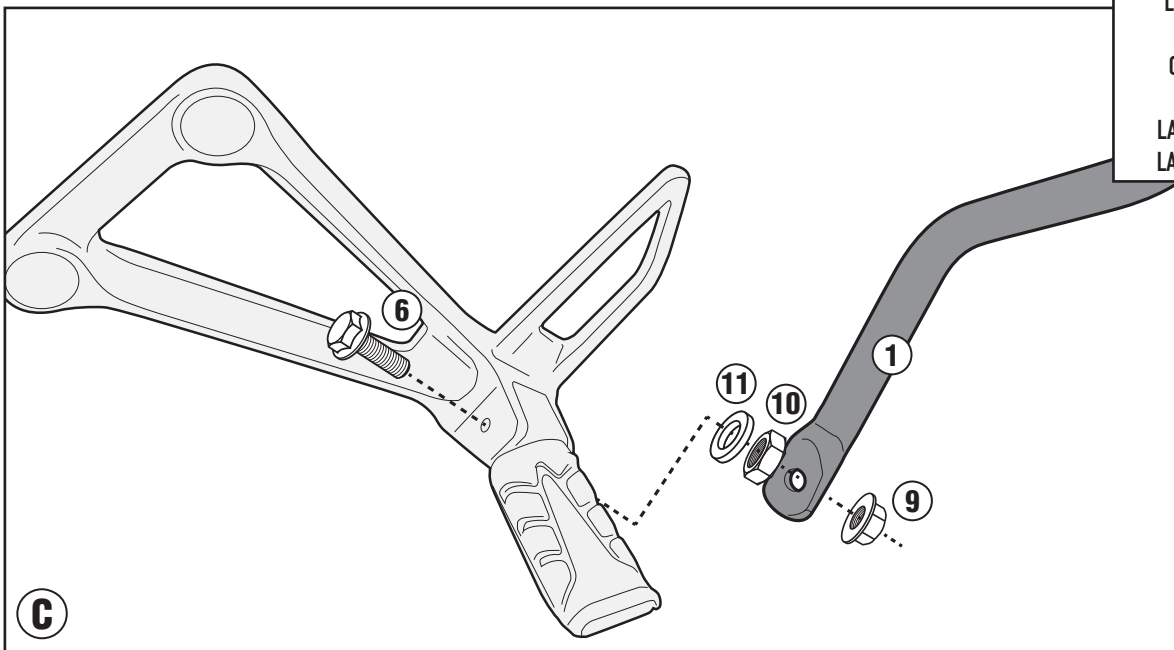

LATO SINISTRO
LEFT SIDE
CÔTÉ GAUCHE
LINKE SEITE
LADO IZQUIERDO
LADO ESQUERDO

PL1121 - KL1121

PORTAVALIGIE LATERALE SPECIFICO - SPECIFIC TUBULAR SIDE-CASE HOLDER - PORTE-VALISES LATÉRAUX SPÉCIFIQUE
SPEZIFISCHES STAHLROHR-SEITENTRAEGER - PORTA MALETAS LATERALES ESPECÍFICO - TRONCO LADO ESPECÍFICO

HONDA CB500X (2013)

